



**NARDI**  
YOUR OUTDOOR LIVING

**CONTRACT**  
2022

contract

design Raffaello Galotto

## C come Contract

Definiamo così le nostre proposte di arredi rivolte al mondo dell'outdoor hospitality: bar, ristoranti, hotel, luxury glamping e molto altro. I nostri mobili sono adatti alla progettazione di ambienti flessibili e versatili, per soddisfare ogni necessità all'aria aperta e per il comfort di fisico e mente.

Li realizziamo con materiali di qualità adatti a restare all'aperto, sono semplici da igienizzare e pratici da movimentare, pensati per un utilizzo intensivo e un lungo ciclo di vita.

All'interno del vasto numero di collezioni, di misure e di colori, tutti gli arredi si distinguono per la loro completa riciclabilità e per una filiera produttiva totalmente Made in Italy

## *C for Contract*

*This is how we describe our furniture solutions intended for the outdoor hospitality world: bars, restaurants, hotels, luxury glamping sites, and much more.*

*Our furniture is ideal for designing flexible and versatile environments to meet all outdoor needs and for the well-being of the body and the mind.*

*We make our furniture using high-quality materials suited to remaining outdoors. Easy to sanitize and practical to move, it is designed for intensive use and a long life cycle.*

*All the furniture included in the huge number of collections, dimensions and colours stands out for being totally recyclable and for its entirely Made in Italy production chain*

# index

12	doga relax
14	doga armchair
16	doga bistrot
18	doga table
26	folio
40	komodo
64	trill armchair
66	trill bistrot
68	trill stool
74	net bench
78	net relax
80	net
82	bit
84	net stool
86	net table
98	bora
100	riva
102	costa
104	darsena
106	acquamarina
108	lido
110	faro
116	aria
124	palma
126	erica
128	gardenia • dalia
132	loto • ninfea
138	frasca
146	clip
150	step • spritz
154	fiore
156	ibisco
158	flute • break
160	scudo
164	cube
170	atlantico • pop
178	alfa • omega
182	<b>regeneration</b>
184	sipario
197	technical details

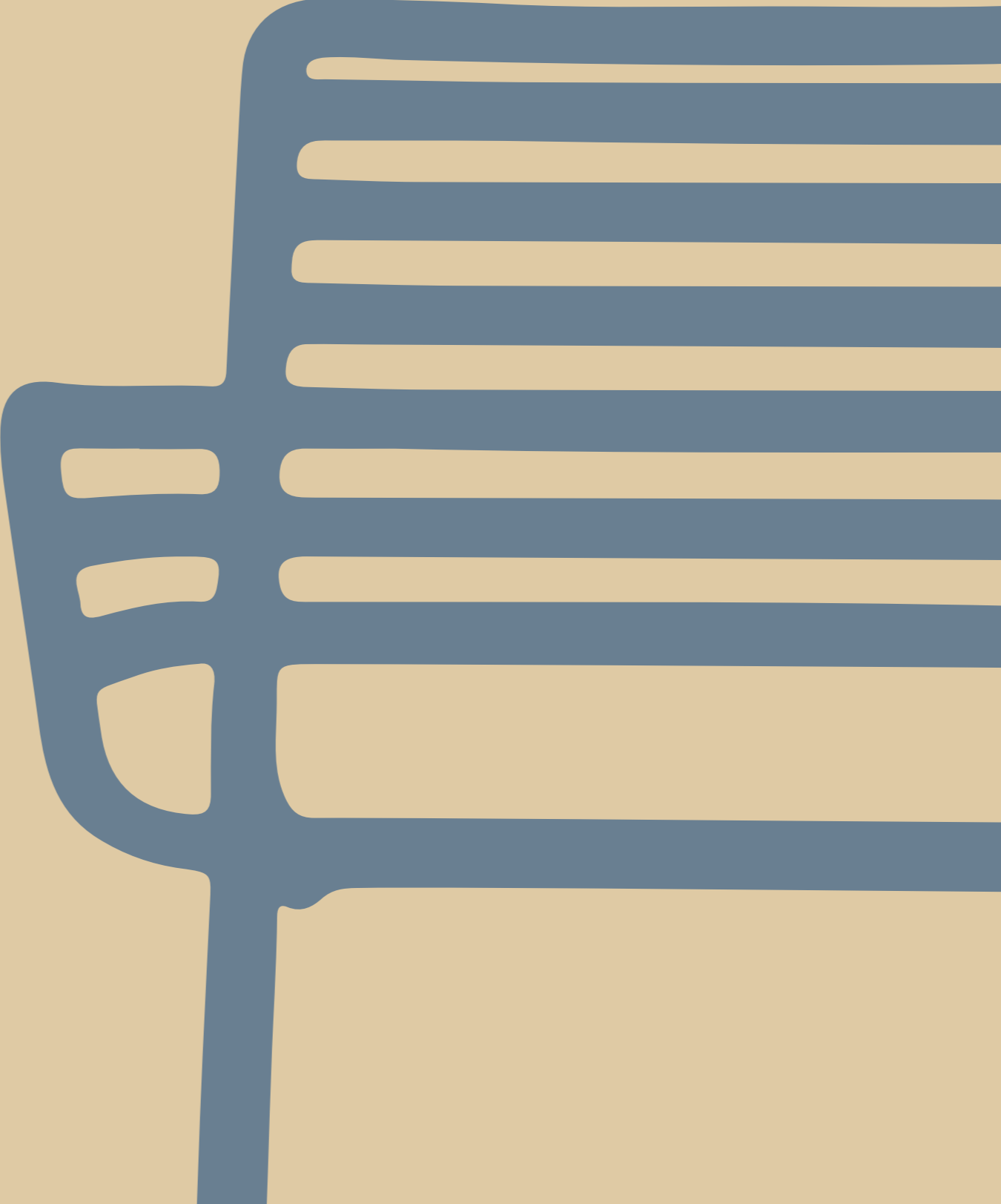



# Doga Relax



**DOGA RELAX**  
marsala



**DOGA RELAX**  
marsala



**DOGA RELAX**  
marsala  
**DOGA TABLE**  
marsala

# Doga Armchair



**DOGA ARMCHAIR**  
pera



**DOGA ARMCHAIR**  
menta - pera - cappuccino - marsala



**DOGA ARMCHAIR**  
pera



# Doga Bistrot



**DOGA BISTROT**  
pera - agave - menta  
**FRASCA MINI FOLDING**  
agave - piano Laminato ø60 agave



# Doga Table



**DOGA TABLE**  
agave  
**DOGA RELAX**  
agave



**DOGA TABLE**  
cappuccino - tabacco - antracite



**DOGA TABLE**  
agave



**DOGA BISTROT**  
agave  
**CUSCINO DOGA BISTROT**  
lino



**DOGA RELAX**  
agave  
**CUSCINO DOGA RELAX**  
lino



**DOGA ARMCHAIR**  
agave  
**CUSCINO DOGA ARMCHAIR**  
lino



**DOGA RELAX  
SPRITZ**

Venice - Italy



**DOGA BISTROT  
FRASCA**

Venice - Italy



**DOGA ARMCHAIR  
FRASCA**

Venice - Italy



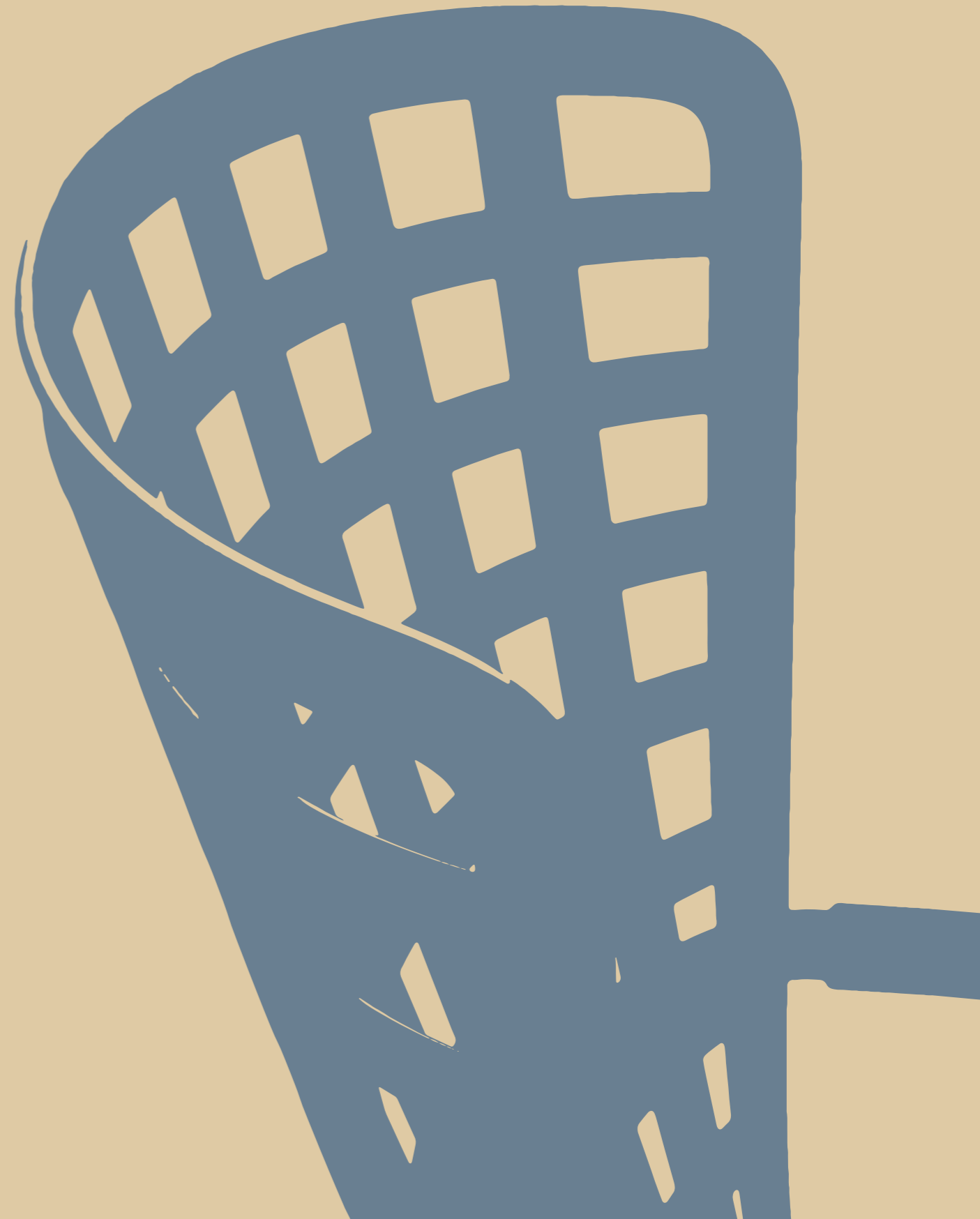

# Folio

FOLIO - FOLIO ROCKING - POGGIO



FOLIO  
agave



FOLIO  
agave

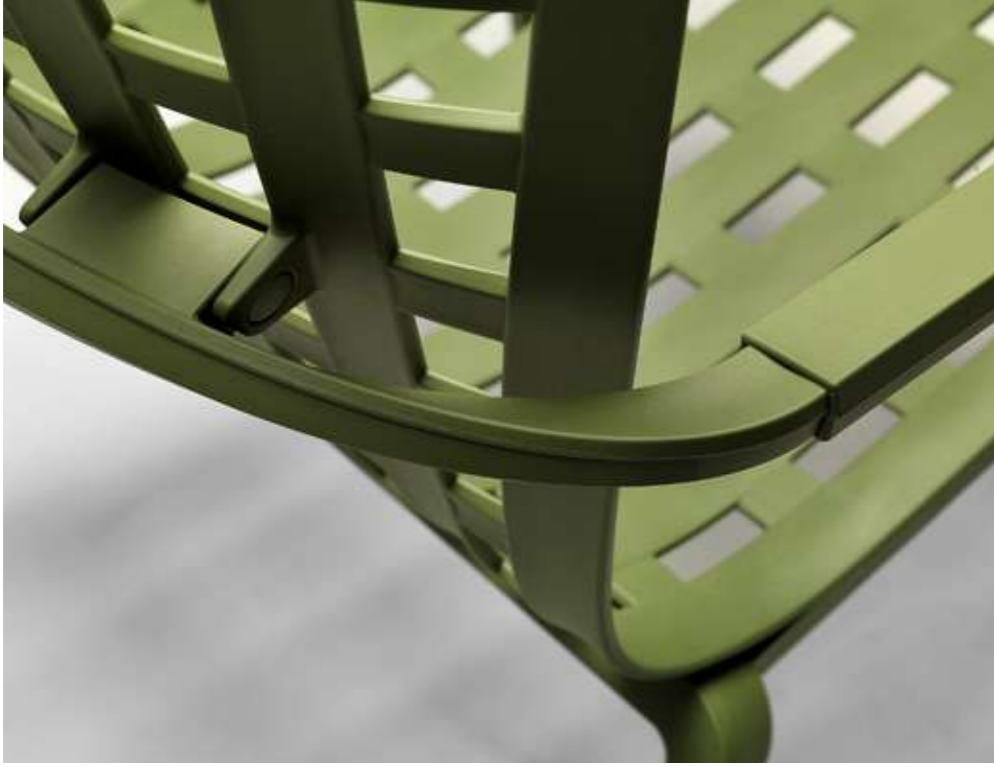

**FOLIO**  
agave



## FOLIO

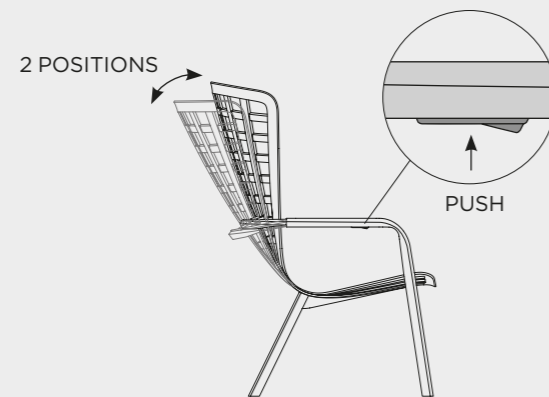

## FOLIO ROCKING

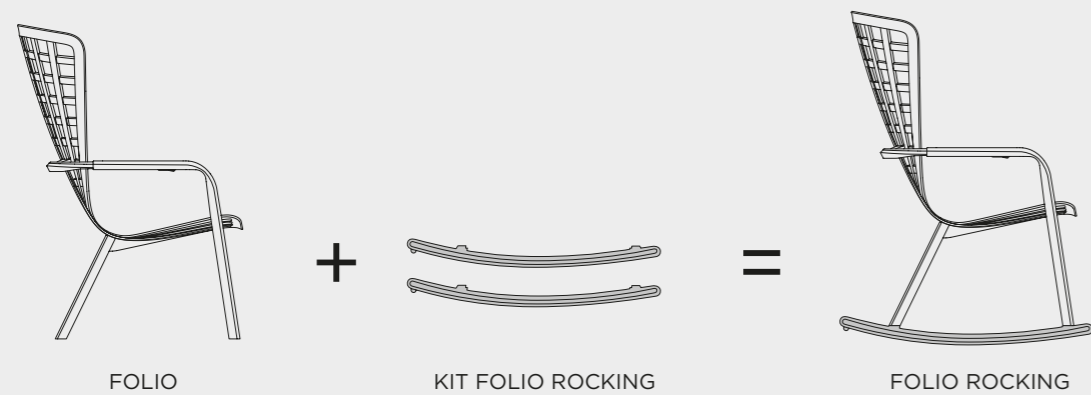

FOLIO è una innovativa poltrona relax a due posizioni pensata per l'outdoor, proposta su base fissa, con poggiatesta, oppure nella romantica versione a dondolo. L'ampia scocca della poltrona è costituita da un unico foglio dal design sapientemente curvato in modo da permettere il movimento tra seduta e schienale sfruttando l'elasticità del materiale senza l'ausilio di elementi di congiunzione o di rotazione.

*FOLIO is an innovative relaxing armchair, adjusting to two positions, designed for outdoor use. It is available with a fixed base and a footrest, or in a romantic rocking version. The large structure of the armchair is made from a single perforated sheet. It has an expertly curved design that allows movement between the seat and back, exploiting the flexibility of the material without requiring any linking or rotating elements.*



**FOLIO ROCKING**  
agave/artic





**FOLIO ROCKING**  
tabacco/felce



**FOLIO**  
agave/artic  
**FOLIO ROCKING**  
bianco/lino - antracite/rosa quarzo



**FOLIO**  
agave  
**POGGIO**  
agave



**POGGIO**  
agave



**POGGIO**  
tabacco - antracite - agave



**FOLIO**  
Asiago - Italy



**FOLIO  
POGGIO**  
Asiago - Italy



**FOLIO ROCKING**  
Asiago - Italy



# Komodo

SISTEMA MODULARE DI SEDUTE  
modular system of upholstered seats



GOOD DESIGN  
AWARD 2019  
winner



GERMAN  
DESIGN  
AWARD  
WINNER  
2020

**KOMODO 5**  
tortora/rosa quarzo



**KOMODO POUF**  
**KOMODO ELEMENTO TERMINALE**  
tortora/rosa quarzo

**KOMODO ELEMENTO CENTRALE**  
**KOMODO ELEMENTO ANGOLO**  
tortora/rosa quarzo

## KOMODO

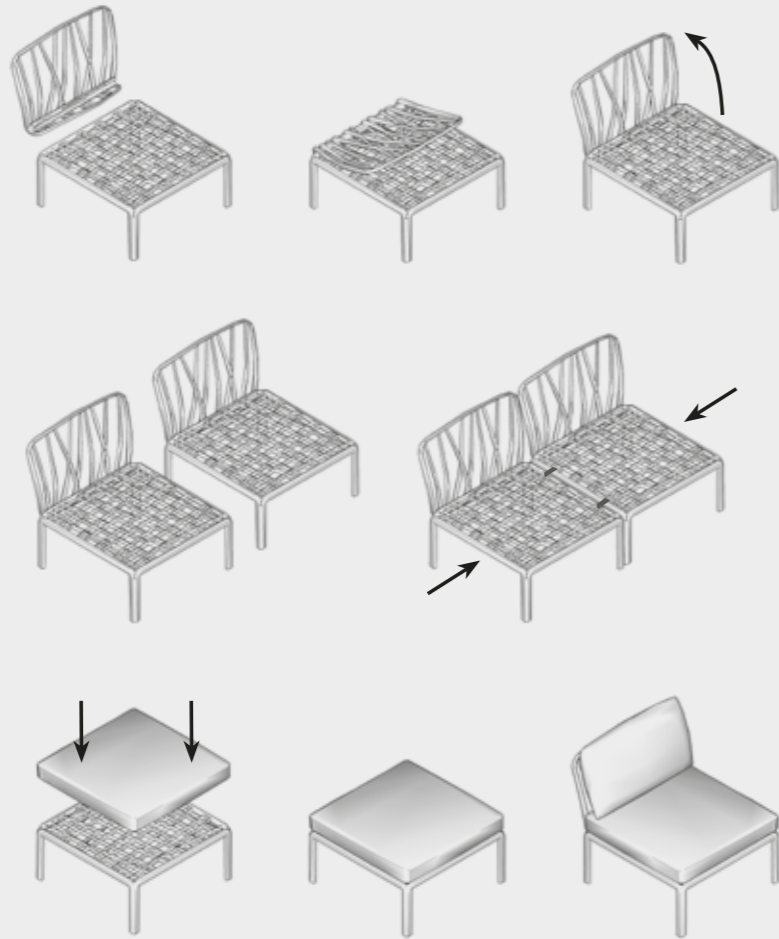

KOMODO è un sistema modulare di sedute configurabile a piacere. I moduli possono essere fissati tra loro e gli schienali e i braccioli sono agganciabili su tutti i lati della seduta. Oltre alla versione standard KOMODO 5, è possibile configurare e ordinare la tua versione personalizzata elencando tutti i singoli elementi che la formano.

*KOMODO is a modular system of upholstered seats which can be configured to suit your particular needs. The modules can be secured to one another and the backrests and armrests can be attached on all sides of the seat.*

*In addition to the standard KOMODO 5 version, you can configure and order your own customized version simply by listing all the individual elements you require.*



**KOMODO POLTRONA**  
tortora/rosa quarzo



**KOMODO OMBRA 3**  
tortora/velo white  
**KOMODO**  
tortora/canvas





**KOMODO OMBRA 2**  
bianco/velo white  
**KOMODO**  
bianco/ghiaccio







**KOMODO**  
agave/avocado



**KOMODO**  
agave/avocado - giungla



**KOMODO**  
bianco/ghiaccio - adriatic



**KOMODO**  
bianco/adriatic



**KOMODO**  
bianco/adriatic



**KOMODO TAVOLINO**  
antracite

**KOMODO TAVOLINO VETRO**  
antracite/vetro  
**KOMODO**  
antracite/grigio komodo



**KOMODO POUF**  
bianco/adriatic - tortora/rosa quarzo - antracite/canvas - grigio komodo



**KOMODO POUF**  
bianco/canvas



**KOMODO**

Riva Event 2019  
(Ferretti Group)  
Venice - Italy

**KOMODO**

Borgo Aratico  
Monopoli - Italy



**KOMODO**

Condominio Riviera del Golf  
Coco del Mar - Panama



**KOMODO  
NET - CALICE**

Loop hotel  
Vilnius - Lithuania



**KOMODO**

Restaurant Sjoslag  
Larvik - Norway







# Trill Armchair



**TRILL ARMCHAIR**  
rosa bouquet  
**FRASCA MINI FIX**  
tortora - piano Laminato 70x70 tortora Fenix



**TRILL ARMCHAIR**  
rosa bouquet



**TRILL ARMCHAIR**  
grigio

# Trill Bistrot



**TRILL BISTROT**  
senape



**TRILL BISTROT**  
ottanio  
**CUSCINO TRILL BISTROT**  
cenere



**TRILL BISTROT**  
senape

# Trill Stool



**TRILL STOOL - TRILL STOOL MINI**  
agave



**TRILL STOOL**  
tabacco  
**FIORE HIGH**  
bianco - piano Laminato 70x70 bianco



**TRILL STOOL**  
agave



**TRILL - CLIP**

15.16 Birroteca e Oltre  
Arzignano - Italy



ph. Rikki Hibbert



**TRILL - IBISCO**

Papillon Wine Bar  
Thiene - Italy



ph. Rikki Hibbert

**TRILL BISTROT  
TRILL STOOL**

Pyramid Office  
Joannesburg - Sud Africa

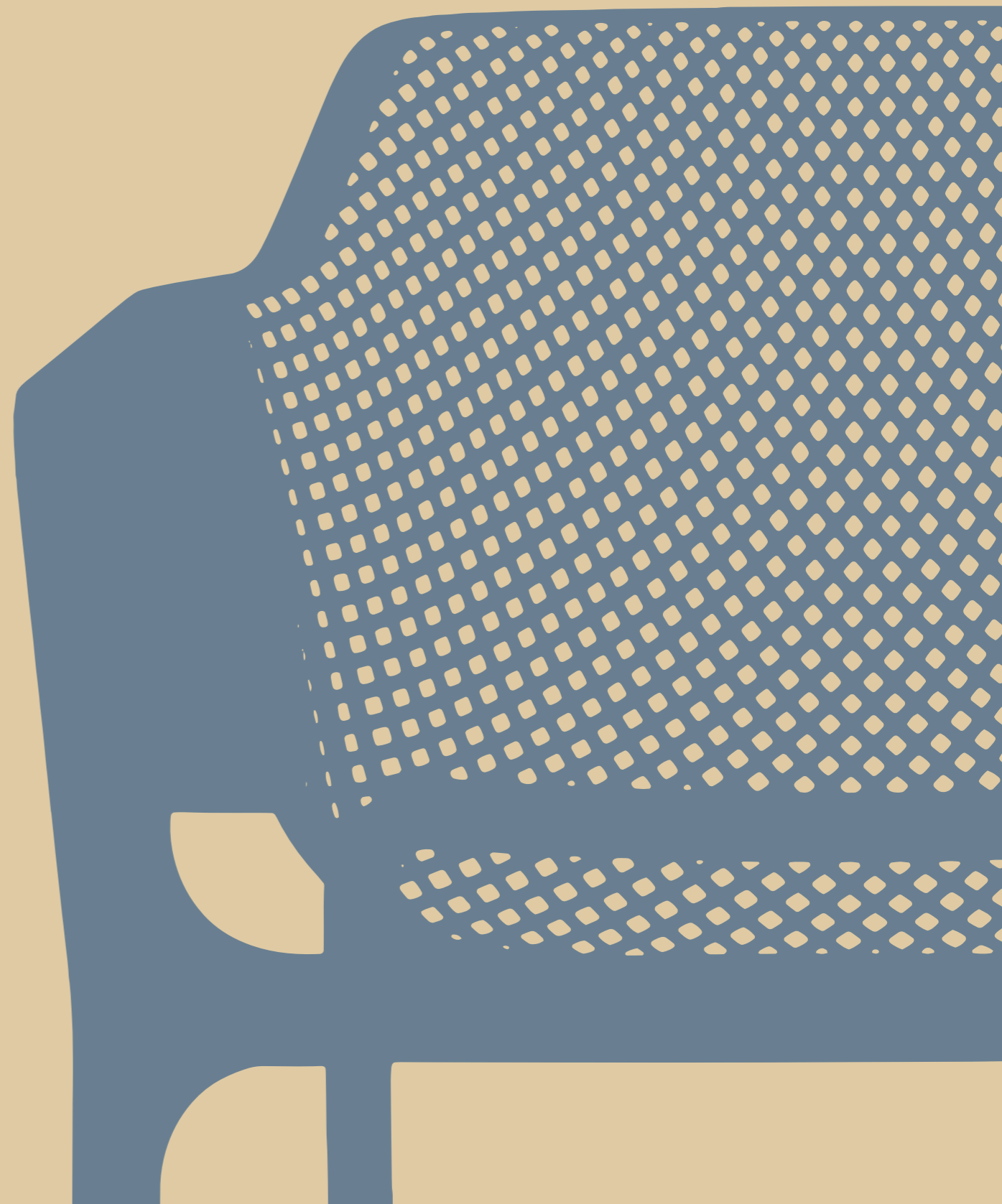

# Net Bench



**NET BENCH**  
antracite - senape  
**CUSCINO NET BENCH**  
grigio



**NET BENCH**  
senape  
**CUSCINO NET BENCH**  
denim



**NET BENCH**  
salice/the verde  
**NET TABLE 100**  
salice



**NET BENCH - NET RELAX - NET TABLE 100**  
tortora  
**CUSCINI NET BENCH - NET RELAX - SHELL**  
denim

# Net relax



**NET RELAX**  
bianco - tortora  
**CUSCINO NET RELAX**  
rosa quarzo



GOOD DESIGN  
AWARD 2018  
winner



reddot award 2018  
winner



selected by  
ADI DESIGN  
INDEX 2017



**NET RELAX**  
antracite  
**CUSCINI NET RELAX - SHELL**  
rosa quarzo





# Net



**NET**  
tortora  
**FIORE**

tortora - piano Laminato 80x80 tortora Fenix



**NET**  
corallo - bianco - antracite  
**CUSCINO NET**  
rosa quarzo - bianco - grigio



**NET**  
antracite

# Bit



**BIT**  
antracite  
**BREAK**  
antracite - piano Laminato ø60 antracite



**BIT**  
salice  
**CUSCINO BIT**  
grigio

# Net Stool



**NET STOOL MINI - NET STOOL**  
tortora



**NET STOOL**  
tortora



**NET STOOL**  
senape

# Net Table





**NET TABLE 100 - NET BENCH**  
bianco



**NET TABLE 100**  
tortora



**NET TABLE 100**  
antracite





ph. Michael Condran



ph. Michael Condran

**NET RELAX - SPRITZ**

Skylark Negril Beach Resort  
Negril - Jamaica



**NET RELAX**

Moncastro Hotel  
Odessa - Ukraine





**NET - BIT**

Llohi Bar  
Brooklyn NY - U.S.A.



**NET - SPRITZ**

A Roma  
Porec - Croatia



**NET - SCUDO**

Madliena Lodge  
Swieqi - Malta



**NET**

Kompot Restaurant  
Deribasovskaya  
Odessa - Ukraine



**BIT - NET - CLIPX**

Kompot Restaurant  
Belinskogo Street  
Odessa - Ukraine





# Bora



**BORA**  
rosso



**BORA - CLIP 70**  
tortora



**BORA BISTROT**  
tortora



# Riva



**RIVA BISTROT - SPRITZ**  
agave



**RIVA**  
bianco  
**FIORE**  
bianco - piano Laminato 70x70 total white



# Costa



**COSTA**  
antracite



**COSTA BISTROT**  
antracite



**COSTA**  
bianco

# Darsena



**DARSENA**  
antracite



**DARSENA**  
antracite



# Acquamarina



**ACQUAMARINA**  
bianco  
**STEP**  
bianco



**ACQUAMARINA**  
tortora

# Lido



**LIDO**  
rosso



**LIDO - LIDO MINI**  
tortora



# Faro



**FARO**  
antracite



**FARO**  
antracite



**FARO**  
tortora  
**FIORE HIGH**  
bianco - piano Laminato 70x70 bianco





**BORA BISTROT  
IBISCO**

Alle Colonne  
Vicenza - Italy

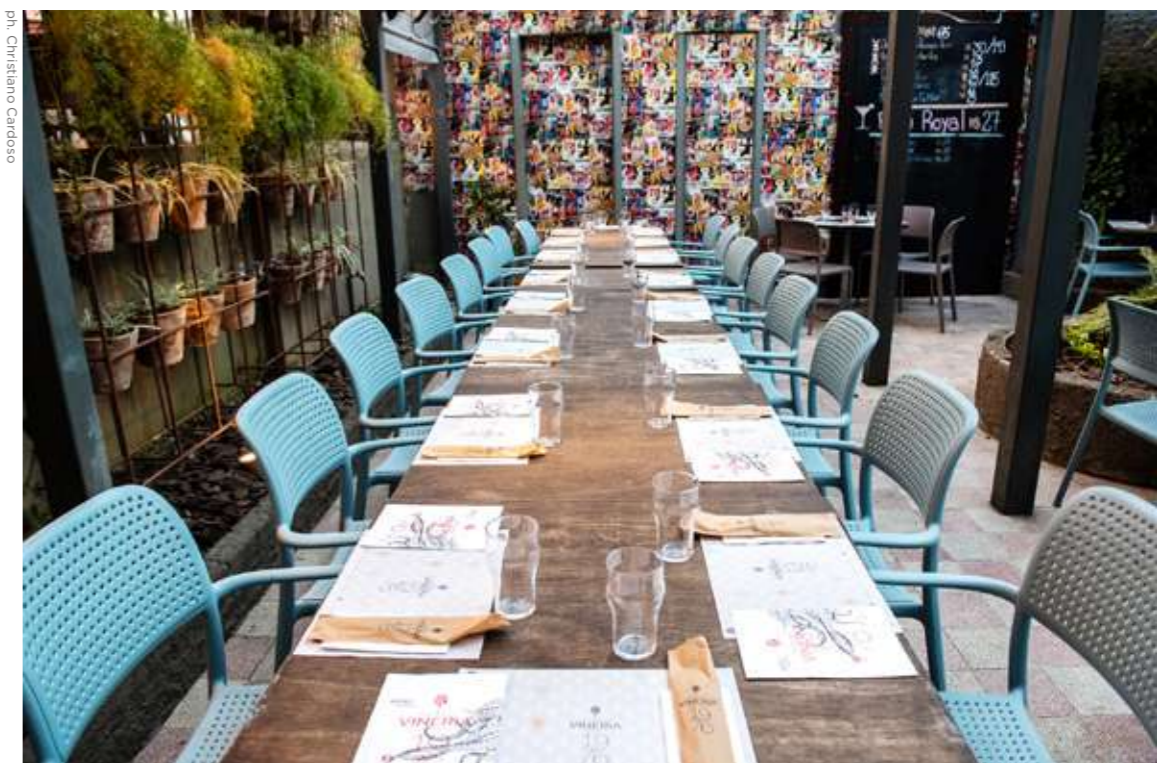

**BORA**

Vineria 1976  
Porto Alegre - Brasil



**BORA BISTROT**

Skylark Negril Beach Resort  
Negril - Jamaica



**COSTA  
COSTA BISTROT**

Feduchy Playa  
Conil de la Frontera - Spain



# Aria



**ARIA FIT**  
tortora/bianco



**ARIA FIT**  
tortora/grigio  
**FIORÉ**  
tortora - piano Laminato 70x70 tortora



**ARIA FIT**  
tortora/bianco



**ARIA POLTRONA**  
bianco/sardinia  
**ARIA TAVOLINO 60**  
bianco



**ARIA POLTRONA**  
tortora/caffè  
**ARIA TAVOLINO 100**  
tortora



**ARIA**  
Ammos Beach Bar  
Kos - Greece



**ARIA**  
Montana Lodge & Spa  
La Thuile - Italy



**ARIA  
STEP MINI**  
Elite Hotel  
Caorle (Venice) - Italy



**ARIA  
FIORE**  
Residenza Amblingh  
Vasto - Italy



# Palma



**PALMA**  
bianco/tortora



**PALMA - CUBE 70**  
tortora



# Erica



**ERICA**  
antracite



**ERICA**  
bianco



**ERICA - CUBE 70**  
bianco



# Gardenia • Dalia



**GARDENIA**  
bianco/tortora



**DALIA**  
tortora





# Loto • Ninfea



**NINFEA RELAX - LOTO RELAX 95**  
antracite



**NINFEA RELAX**  
bianco



**LOTO RELAX 95 - LOTO RELAX 60**  
bianco



**NINFEA DINNER**  
antracite  
**FLUTE**  
antracite - piano Laminato ø60 antracite



**NINFEA DINNER**  
antracite



**NINFEA DINNER**  
bianco

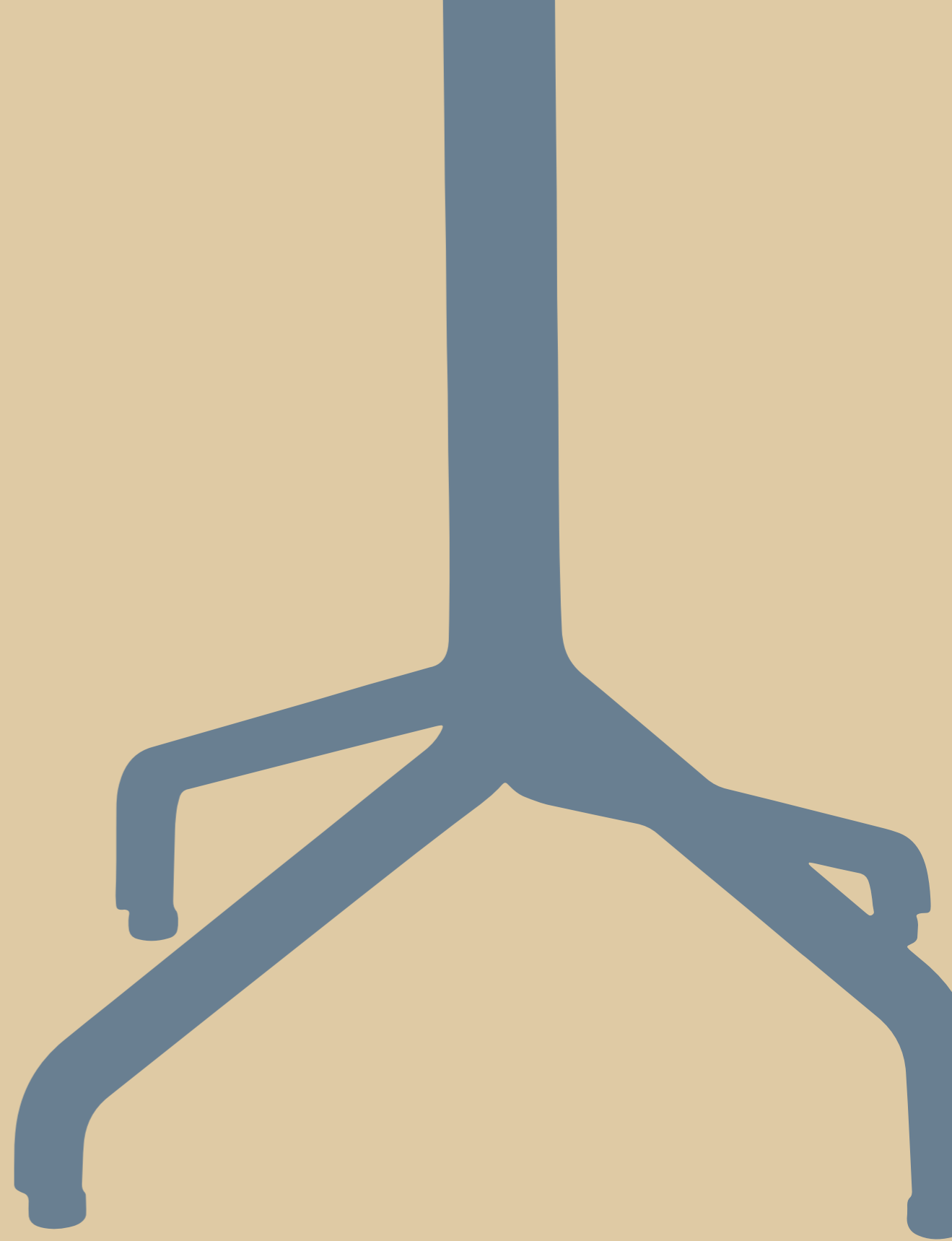

# Frasca





**FRASCA MAXI FIX**  
agave - piano Laminato 90x90 agave  
**FRASCA MINI FOLDING**  
agave - piano Laminato 70x70 agave



**FRASCA MINI**  
agave



**FRASCA MINI FOLDING**  
 antracite - tortora - bianco - agave  
 piani Laminato 70x70



**FRASCA HIGH FOLDING**  
**FRASCA MINI FOLDING**  
 tabacco  
 piano Laminato 70x70 tabacco



**FRASCA MINI FIX**  
 bianco - tortora - antracite - agave  
 piani Laminato ø70



**FRASCA MINI FIX**  
**FRASCA HIGH FIX**  
 tabacco  
 piano Laminato ø70 tabacco





**FRASCA MAXI FIX**  
agave - piano Laminato 90x90 agave  
**TRILL BISTROT**  
agave



**FRASCA MAXI FIX**  
agave - piano Laminato 90x90 agave  
**TRILL BISTROT**  
agave

# Clip



**CLIP 80 - CLIP 70 - BORA**  
tortora



**CLIP 80 - BORA**  
tortora

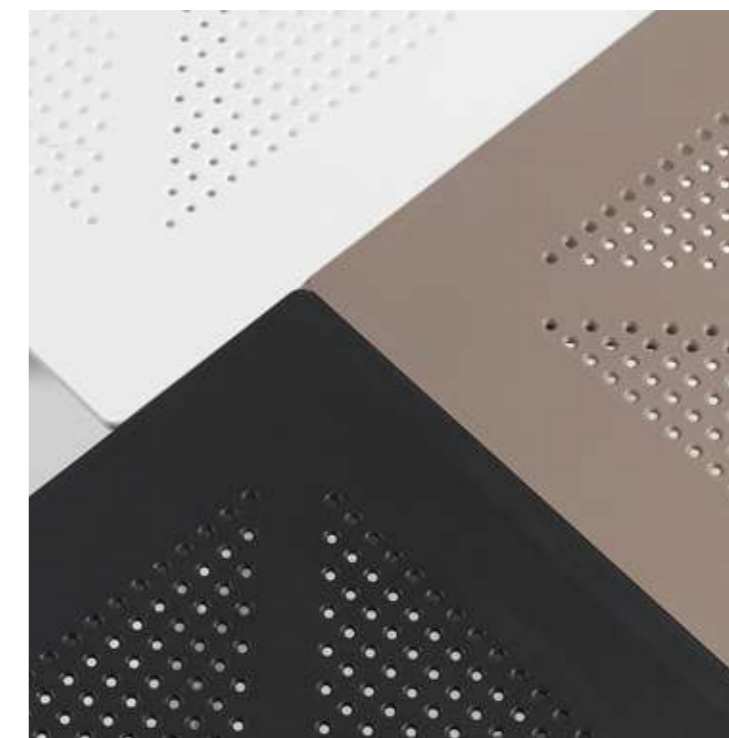

**CLIP 70**  
bianco - antracite - tortora



**CLIPX 80 - NET**  
tortora



**BASE CLIP**  
bianco - piano Laminato 70x70 total white

# Step • Spritz





**STEP**  
rosso



**STEP - BORA BISTROT**  
tortora



**SPRITZ**  
antracite  
**SPRITZ MINI**  
tortora

# Fiore



**FIORE HIGH - FIORE**  
bianco - piano Laminato 70x70 total white  
**FARO - RIVA BISTROT**  
celeste



**FIORE**  
bianco - piano Laminato 70x70 total white



# Ibisco



**IBISCO**  
tortora - piano Laminato 80x80 tortora



**IBISCO HIGH**  
antracite - piano Laminato 70x70 antracite

# Flute • Break



**FLUTE**  
tortora  
piano Laminato ø70 tortora



**FLUTE**  
bianco - piano Laminato ø70 bianco



**FLUTE**  
antracite - piano Laminato ø70 antracite



**BREAK**  
bianco - piano Laminato ø70 bianco



**BREAK**  
antracite - piano Laminato ø70 antracite



# Scudo



**SCUDO DOUBLE**  
antracite



**SCUDO**  
tortora  
piano Laminato 80x80 tortora



**SCUDO - SCUDO HIGH**  
tortora  
piano Laminato 70x70 tortora



# Cube



**CUBE 70**  
tortora



**CUBE 80 - PALMA**  
tortora



**CUBE 80 - 70 - 70 HIGH**  
tortora



**CUBE 140x80**  
tortora



**CUBE 140x80 - 140x80 HIGH**  
tortora



**CUBE 140x80 HIGH**  
bianco  
**NET STOOL**  
bianco

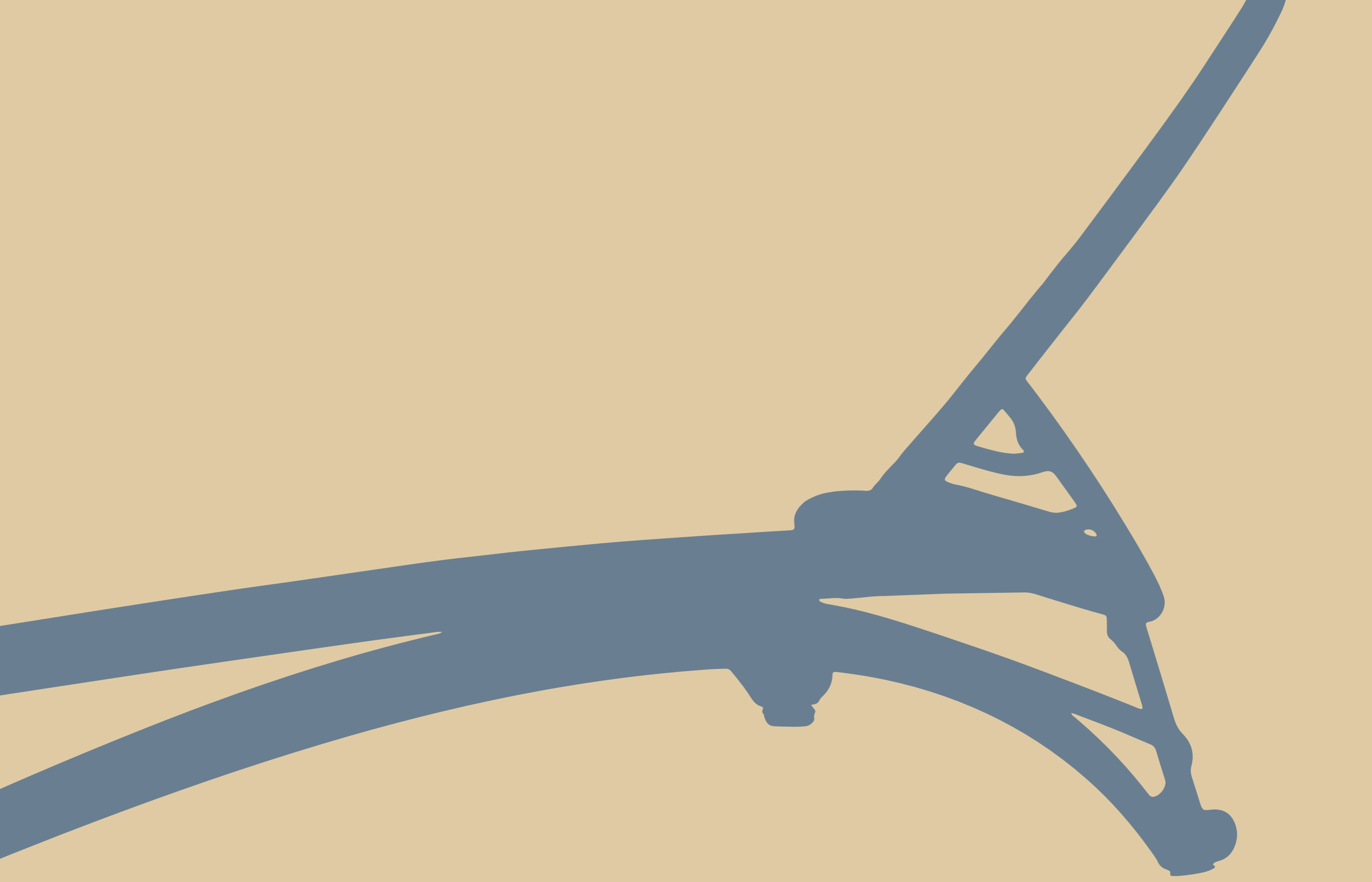

# Atlantico • Pop



**ATLANTICO**  
tortora/deserto - tortora/agave



**ATLANTICO - POP**  
antracite



**POP**  
tortora



**ATLANTICO**  
tortora/tortora

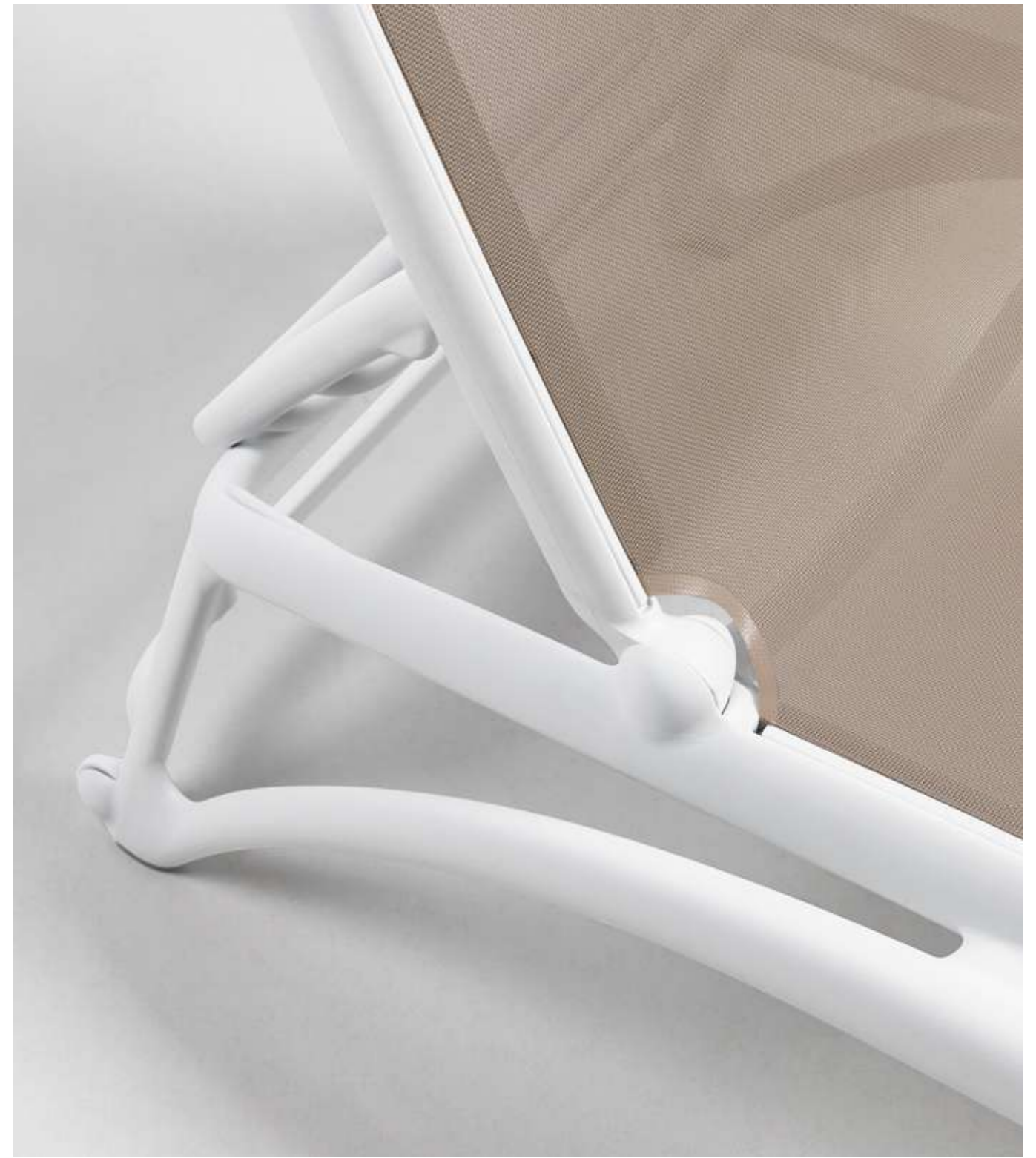

**ATLANTICO**  
bianco/tortora



**ATLANTICO**

Le Nautique Luxury  
Waterfront Hotel  
La Digue - Seychelles



**ATLANTICO  
POP**

Ammos Beach Bar  
Kos - Greece



**ATLANTICO**

Calheta Boutique Houses  
Madeira - Portugal



**ATLANTICO  
POP**

Moncastro Hotel  
Odessa - Ukraine





ph. Daniele Brasca

**ATLANTICO**

Borgo Aratico  
Monopoli - Italy



ph. Raffaele Marmello



NARDI • CONTRACT

**ATLANTICO**

Sinjura Xaghra Holiday Home  
Gozo - Malta



ph. Raffaele Marmello

**ATLANTICO**

Laghi Nabi - Parco Benessere  
Campania - Italy

# Alfa • Omega



**OMEGA**  
grigio/grigio



**ALFA**  
tortora/tortora



**OMEGA**  
Cave Bianche Hotel  
Trapani - Italy



**OMEGA**  
Agrumare Farm Holiday  
Matera - Italy

**OMEGA**  
Horizon Beach Resort  
Kos - Greece

# regeneration

*Our commitment to making environmentally sustainable products with high added value led us to launch the Regeneration industrial programme, in 2019, for the production of outdoor furniture in recycled plastic.*

*We make our products at a production plant designed with cutting-edge plant engineering technology. It is equipped with energy-saving hybrid injection presses, with an air-based cooling system without using water and consuming very little electricity. Most of the electricity used is produced by a photovoltaic panel system.*

*Regeneration is much more than a simple line of recycled plastic products. It allows us to experiment with solutions that can be applied on a large scale to the entire production cycle and involves all steps, from the concept creation of individual furniture items to their packaging.*

*For the Regeneration line, all protective packaging and related internal supports are made of FSC-certified recycled cardboard and fully recyclable low-density polyethylene, both designed to minimise their use.*

*Lastly, every day we strive to gradually implement actions to improve our environmental performance by means of LCA (Life Cycle Assessment) analysis, an analytical and systematic methodology that assesses the environmental footprint of our new products throughout their entire life cycle.*

For more information visit [www.nardioutdoor.com/regeneration](http://www.nardioutdoor.com/regeneration)

# regeneration

Il nostro impegno nel realizzare prodotti dall'alto valore aggiunto e sostenibili per l'ambiente ci ha portati a inaugurare nel 2019 il programma industriale Regeneration per la produzione di arredi per esterno in plastica riciclata.

Li facciamo in uno stabilimento progettato con tecnologie all'avanguardia a livello impiantistico, dotato di presse a iniezione ibride ad alto risparmio energetico nelle quali il sistema di raffreddamento utilizza l'aria senza impiegare acqua e consumando pochissima energia elettrica. Quest'ultima è generata, in gran parte, da un sistema di pannelli fotovoltaici.

Regeneration è molto più di una semplice linea di prodotti in plastica riciclata e ci permette di sperimentare soluzioni applicabili su larga scala a tutto il ciclo produttivo coinvolgendo tutte le fasi, dall'ideazione dei singoli arredi fino al loro imballaggio.

Per quest'ultimo aspetto per la linea Regeneration tutti gli imballi di protezione e i relativi sostegni interni sono in cartone riciclato certificato FSC e polietilene a bassa densità completamente riciclabile, entrambi progettati in modo da ridurre al minimo il loro impiego.

Infine, ci impegniamo ogni giorno a mettere progressivamente in atto azioni per migliorare le nostre performance ambientali grazie alle analisi LCA (Life Cycle Assessment), metodologia analitica e sistematica che valuta l'impronta ambientale dei nostri nuovi prodotti lungo il loro intero ciclo di vita.

Per maggiori informazioni visita [www.nardioutdoor.com/regeneration](http://www.nardioutdoor.com/regeneration)

# Sipario

ECO PARTITION



**SIPARIO 2**  
terra  
**TRILL BISTROT**  
senape



**SIPARIO 3**  
terra  
**TRILL BISTROT**  
senape  
**FRASCA MINI FIX**  
tortora



SIPARIO 3





ALCUNE POSSIBILI CONFIGURAZIONI  
SOME POSSIBLE CONFIGURATIONS

FONDO DRENANTE  
DRAINAGE BASE

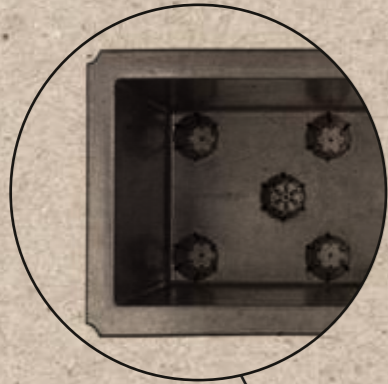

FORO DI RIEMPIMENTO SERBATOIO  
HOLE FOR FILLING RESERVOIR

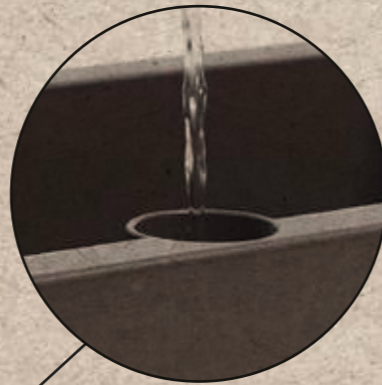

VASO AUTOIRRIGANTE  
SELF-WATERING PLANTER

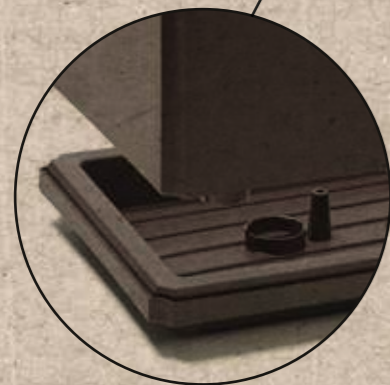

SOTTOVASO - SERBATOIO CON TROPPOPIENO  
PLANTER TRAY - RESERVOIR WITH  
OVERFLOW HOLE



INDICATORE DI LIVELLO DELL'ACQUA  
WATER LEVEL INDICATOR

MIN

MAX



SIPARIO



# SIPARIO

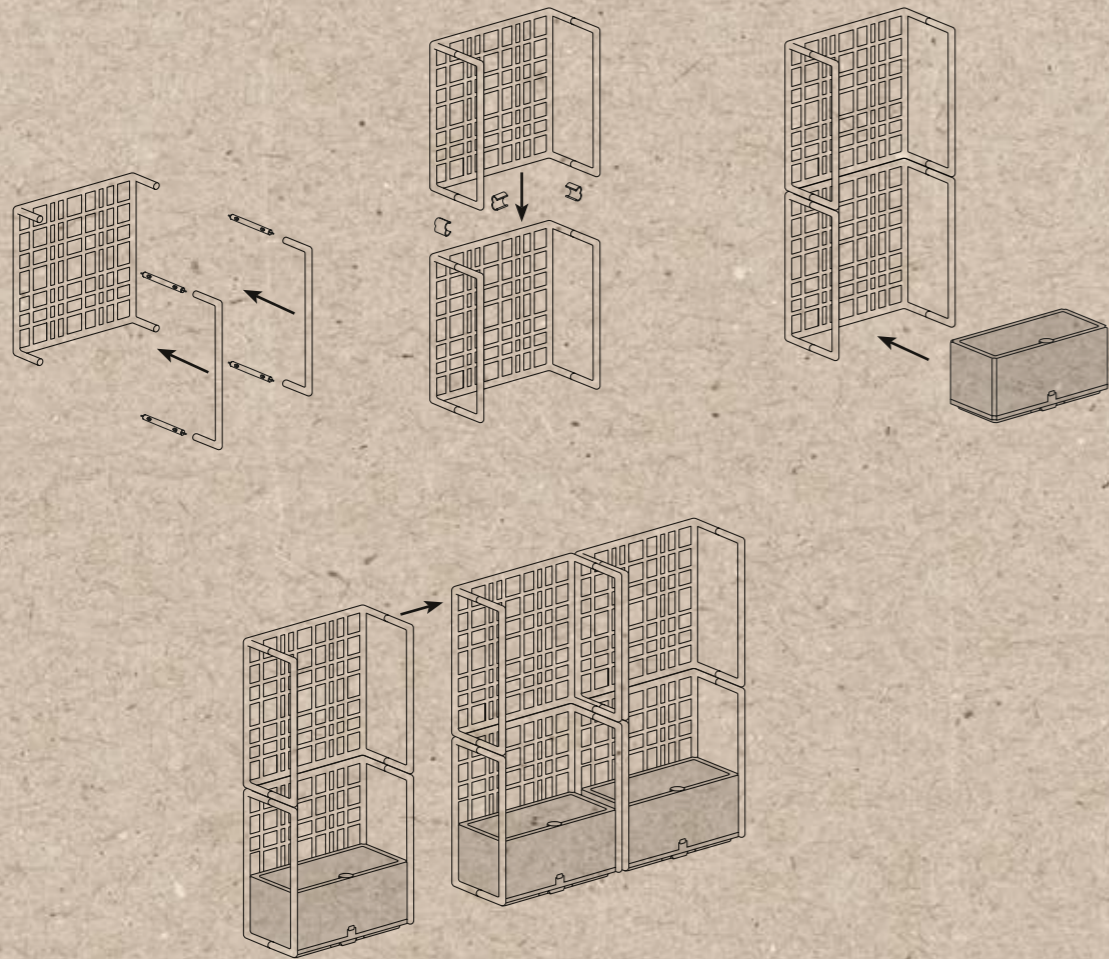

SIPARIO è un divisorio modulare autoportante da esterno configurabile a piacere, ideale per dividere gli spazi aperti. È costituito da elementi grigliati facilmente agganciabili tra loro senza l'uso di viti e dotato di vaso contenitore per piante. È realizzato in plastica rigenerata

*SIPARIO, a free-standing modular partition for outdoor use, can be configured as required and is ideal for separating open spaces. It consists of grid elements, easily hooked together without using screws, and includes a container for plants. It's made of regenerated plastic*

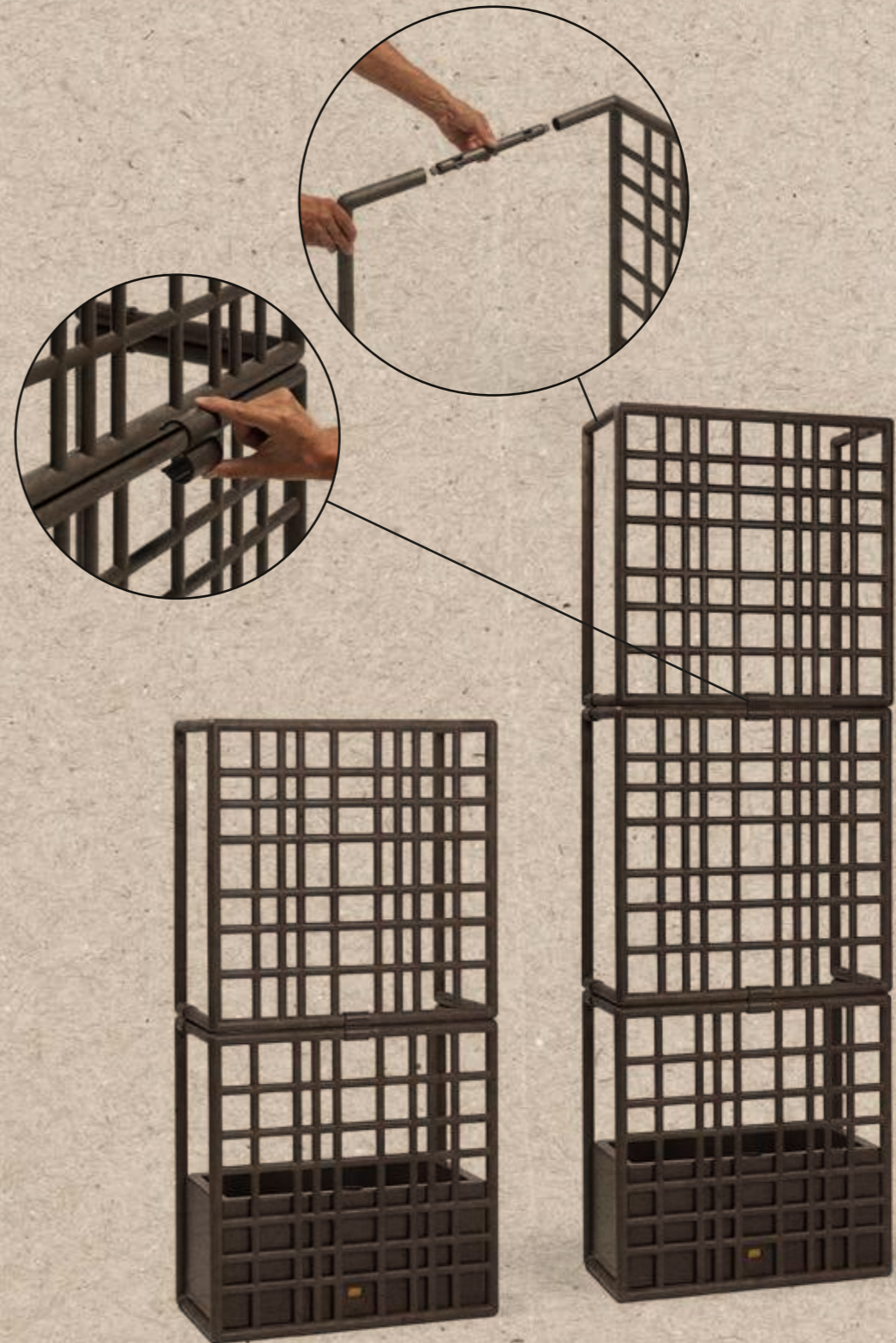

SIPARIO 2 - SIPARIO 3



NARDI • CONTRACT

**SIPARIO  
TRILL  
FRASCA  
KOMODO**

Alonte - Italy



**SIPARIO  
TRILL  
FRASCA**

Cave Bianche Hotel  
Trapani - Italy

schede tecniche  
*technical details*

## FOLIO

polipropilene fiberglass

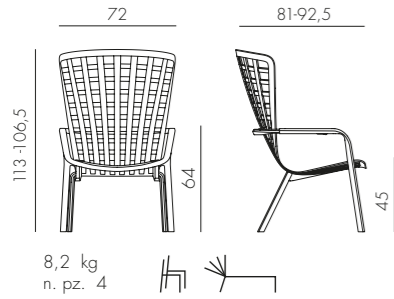

8,2 kg  
n. pz. 4

## KIT FOLIO ROCKING

polipropilene fiberglass

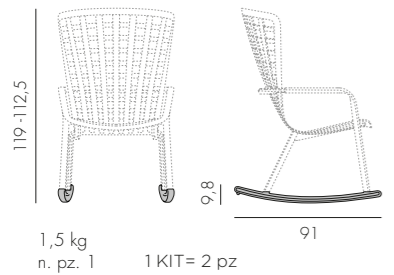

1,5 kg  
n. pz. 1  
1 KIT= 2 pz

## POGGIO

polipropilene fiberglass

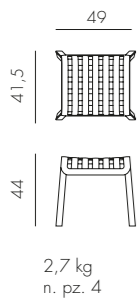

2,7 kg  
n. pz. 4

## CUSCINO FOLIO COMFORT

tessuto

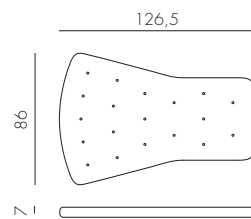

1,4 kg  
n. pz. 1

## KOMODO POLTRONA

polipropilene fiberglass  
tessuto

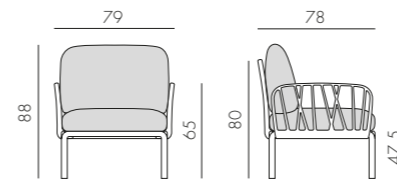

14,3 kg  
n. pz. 1

## KOMODO ELEMENTO TERMINALE DX/SX

polipropilene fiberglass  
tessuto

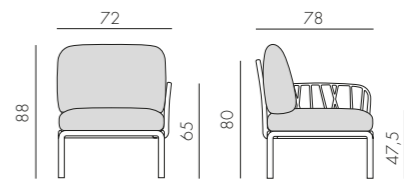

12,6 kg  
n. pz. 1

## KOMODO ELEMENTO CENTRALE

polipropilene fiberglass  
tessuto

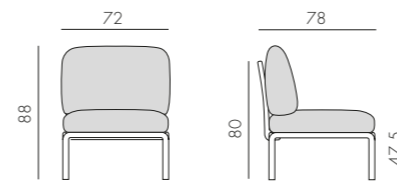

10,9 kg  
n. pz. 1

## KOMODO ELEMENTO ANGOLO

polipropilene fiberglass  
tessuto

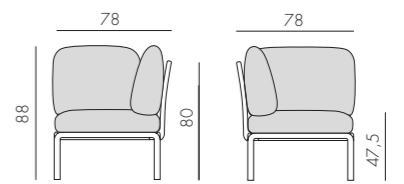

14 kg  
n. pz. 1

## KOMODO POUF

polipropilene fiberglass  
tessuto

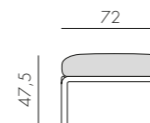

7,5 kg  
n. pz. 1

## KOMODO 5



polipropilene fiberglass  
tessuto

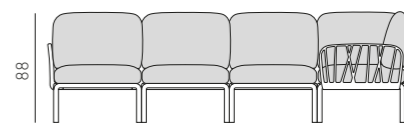
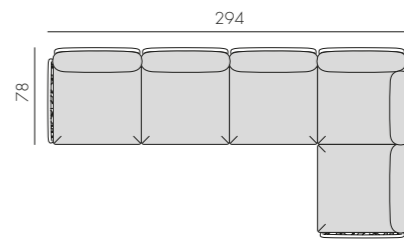

61 kg  
n. pz. 1

# Variazioni di colore sono da ritenersi standard e naturali nei tessuti acrilici tinto filo. Posizionare in zone d'ombra - Colour variations are to be considered standard and natural in yarn-dyed acrylic fabrics. Position in shaded areas - Les variations de couleur des tissus acryliques au fil teint sont standard et naturelles. Placer dans des zones ombragées - Farbveränderungen sind als Standard und in im Garn gefärbten Acrylgeweben als natürlich zu betrachten. In schattigen Bereichen aufstellen - Las variaciones de color son normales y naturales en las telas acrílicas teñidas en hilo. Colocar en zonas de sombra - As variações de cor são consideradas standard e naturais nos tecidos acrílico tingidos com fio. Posicionar em zonas de sombra - Boyalı akrilik iplik kumaşlarda renk değişiklikleri standart ve doğal kabul edilir. Gölgeli alanlara yerleştiriniz - Изменения цвета следует считать нормой, они являются естественными в случае акриловых тканей с окрашенными волокнами. Размещать в тени



Life Cycle Assessment

For more information visit [www.nardioutdoor.com/sustainability](http://www.nardioutdoor.com/sustainability)



	POLTRONA	ELEMENTO TERMINALE DX/SX	ELEMENTO CENTRALE	ELEMENTO ANGOLO	POUF	KOMODO 5	
BIANCO rosa quarzo #		40371.00.066	40372.00.066	40373.00.066	40374.00.066	40369.00.066	40370.00.066
ANTRACITE rosa quarzo #		40371.02.066	40372.02.066	40373.02.066	40374.02.066	40369.02.066	40370.02.066
TORTORA rosa quarzo #		40371.10.066	40372.10.066	40373.10.066	40374.10.066	40369.10.066	40370.10.066
AGAVE rosa quarzo #		40371.16.066	40372.16.066	40373.16.066	40374.16.066	40369.16.066	40370.16.066
BIANCO grigio Komodo		40371.00.172	40372.00.172	40373.00.172	40374.00.172	40369.00.172	40370.00.172
ANTRACITE grigio Komodo		40371.02.172	40372.02.172	40373.02.172	40374.02.172	40369.02.172	40370.02.172
TORTORA grigio Komodo		40371.10.172	40372.10.172	40373.10.172	40374.10.172	40369.10.172	40370.10.172
AGAVE grigio Komodo		40371.16.172	40372.16.172	40373.16.172	40374.16.172	40369.16.172	40370.16.172

# Variazioni di colore sono da ritenersi standard e naturali nei tessuti acrilici tinto filo. Posizionare in zone d'ombra - Colour variations are to be considered standard and natural in yarn-dyed acrylic fabrics. Position in shaded areas - Les variations de couleur des tissus acryliques au fil teint sont standard et naturelles. Placer dans des zones ombragées - Farbveränderungen sind als Standard und in im Garn gefärbten Acrylgeweben als natürlich zu betrachten. In schattigen Bereichen aufstellen - Las variaciones de color son normales y naturales en las telas acrílicas teñidas en hilo. Colocar en zonas de sombra - As variações de cor são consideradas standard e naturais nos tecidos acrílico tingidos com fio. Posicionar em zonas de sombra - Boyalı akrilik iplik kumaşlarda renk değişiklikleri standart ve doğal kabul edilir. Gölgeli alanlara yerleştiriniz - Изменения цвета следует считать нормой, они являются естественными в случае акриловых тканей с окрашенными волокнами. Размещать в тени



	POLTRONA	ELEMENTO TERMINALE DX/SX	ELEMENTO CENTRALE	ELEMENTO ANGOLO	POUF	KOMODO 5	
BIANCO adriatic Sunbrella® *		40371.00.142	40372.00.142	40373.00.142	40374.00.142	40369.00.142	40370.00.142
ANTRACITE adriatic Sunbrella® *		40371.02.142	40372.02.142	40373.02.142	40374.02.142	40369.02.142	40370.02.142
TORTORA adriatic Sunbrella® *		40371.10.142	40372.10.142	40373.10.142	40374.10.142	40369.10.142	40370.10.142
AGAVE adriatic Sunbrella® *		40371.16.142	40372.16.142	40373.16.142	40374.16.142	40369.16.142	40370.16.142
BIANCO ghiaccio Sunbrella® *		40371.00.138	40372.00.138	40373.00.138	40374.00.138	40369.00.138	40370.00.138
ANTRACITE ghiaccio Sunbrella® *		40371.02.138	40372.02.138	40373.02.138	40374.02.138	40369.02.138	40370.02.138
TORTORA ghiaccio Sunbrella® *		40371.10.138	40372.10.138	40373.10.138	40374.10.138	40369.10.138	40370.10.138
AGAVE ghiaccio Sunbrella® *		40371.16.138	40372.16.138	40373.16.138	40374.16.138	40369.16.138	40370.16.138

\* Trattamento laminato su richiesta con quantità minima - Laminated finish available on request with a minimum quantity - Traitement laminé sur demande avec une quantité minimum - Lamierte Ausrüstung auf Anfrage mit einer Mindestmenge - Tratamiento laminado bajo pedido con una cantidad mínima - Tratamento laminado sob encomenda com quantidade mínima - Talep üzerine minimum miktarda lamine işlem - Ламинированная обработка по запросу с минимальным количеством



BIANCO avocado Sunbrella® *		40371.00.139	40372.00.139	40373.00.139	40374.00.139	40369.00.139	40370.00.139
ANTRACITE avocado Sunbrella® *		40371.02.139	40372.02.139	40373.02.139	40374.02.139	40369.02.139	40370.02.139
TORTORA avocado Sunbrella® *		40371.10.139	40372.10.139	40373.10.139	40374.10.139	40369.10.139	40370.10.139
AGAVE avocado Sunbrella® *		40371.16.139	40372.16.139	40373.16.139	40374.16.139	40369.16.139	40370.16.139

BIANCO giungla Sunbrella® *		40371.00.140	40372.00.140	40373.00.140	40374.00.140	40369.00.140	40370.00.140
ANTRACITE giungla Sunbrella® *		40371.02.140	40372.02.140	40373.02.140	40374.02.140	40369.02.140	40370.02.140
TORTORA giungla Sunbrella® *		40371.10.140	40372.10.140	40373.10.140	40374.10.140	40369.10.140	40370.10.140
AGAVE giungla Sunbrella® *		40371.16.140	40372.16.140	40373.16.140	40374.16.140	40369.16.140	40370.16.140

\* Trattamento laminato su richiesta con quantità minima - Laminated finish available on request with a minimum quantity - Traitement laminé sur demande avec une quantité minimum - Lamierte Ausrüstung auf Anfrage mit einer Mindestmenge - Tratamiento laminado bajo pedido con una cantidad mínima - Tratamiento laminado sob encomenda com quantidade mínima - Talep üzerine minimum miktarda lamine işlem - Ламинированная обработка по запросу с минимальным количеством



BIANCO canvas Sunbrella® *		40371.00.141	40372.00.141	40373.00.141	40374.00.141	40369.00.141	40370.00.141
ANTRACITE canvas Sunbrella® *		40371.02.141	40372.02.141	40373.02.141	40374.02.141	40369.02.141	40370.02.141
TORTORA canvas Sunbrella® *		40371.10.141	40372.10.141	40373.10.141	40374.10.141	40369.10.141	40370.10.141
AGAVE canvas Sunbrella® *		40371.16.141	40372.16.141	40373.16.141	40374.16.141	40369.16.141	40370.16.141

BIANCO TECH panama		40371.00.131	40372.00.131	40373.00.131	40374.00.131	40369.00.131	40370.00.131
ANTRACITE TECH panama		40371.02.131	40372.02.131	40373.02.131	40374.02.131	40369.02.131	40370.02.131
TORTORA TECH panama		40371.10.131	40372.10.131	40373.10.131	40374.10.131	40369.10.131	40370.10.131
AGAVE TECH panama		40371.16.131	40372.16.131	40373.16.131	40374.16.131	40369.16.131	40370.16.131

\* Trattamento laminato su richiesta con quantità minima - Laminated finish available on request with a minimum quantity - Traitement laminé sur demande avec une quantité minimum - Lamierte Ausrüstung auf Anfrage mit einer Mindestmenge - Tratamiento laminado bajo pedido con una cantidad mínima - Tratamiento laminado sob encomenda com quantidade mínima - Talep üzerine minimum miktarda lamine işlem - Ламинированная обработка по запросу с минимальным количеством

Tessuti disponibili su ordinazione per minimi quantitativi d'ordine - Fabrics available to order for minimum order quantities - Tissus disponibles sur commande de quantités minimales - Gewebe auf Bestellung für Mindestbestellmengen erhältlich - Telas disponibles bajo pedido para cantidades mínimas - Tecidos disponíveis por encomenda para quantidades mínimas de encomenda - Minimum sipariş miktarına göre sipari verilebilecek mevcut kumaşlar - ткани на заказ для минимального объема заказа.

Sunbrella®  
EXTRA \*

pp. 254

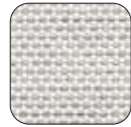

marble  
Sunbrella® .186



blue storm  
Sunbrella® .185

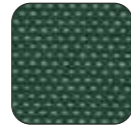

alpine  
Sunbrella® .182

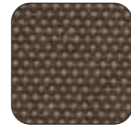

mink brown  
Sunbrella® .183

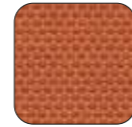

pumpkin  
Sunbrella® .184

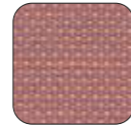

opera  
Sunbrella® .187

Nardi  
Acrylici/Acrylic #

pp. 252



grey stone .064



artic .161



sardinia .072

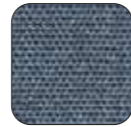

denim .070

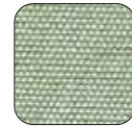

the verde .071



lime .061



felce .162



senape .069



cherry .065

## KOMODO TAVOLINO

polipropilene fiberglass

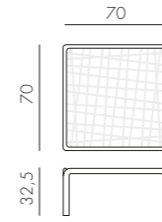

6,7 kg  
n. pz. 1



BIANCO  
40378.00.000



ANTRACITE  
40378.02.000



TORTORA  
40378.10.000



AGAVE  
40378.16.000

## KOMODO TAVOLINO VETRO

polipropilene fiberglass  
vetro



11,4 kg  
n. pz. 1



BIANCO  
vetro  
40368.00.501



ANTRACITE  
vetro  
40368.02.501



TORTORA  
vetro  
40368.10.501



AGAVE  
vetro  
40368.16.501

## KOMODO OMBRA 3 **new**

polipropilene fiberglass  
tessuto

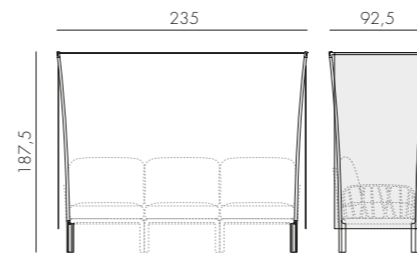

2,9 kg  
n. pz. 1

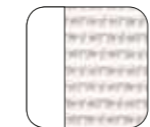

BIANCO  
velo white  
40408.00.203



ANTRACITE  
velo white  
40408.02.203



TORTORA  
velo white  
40408.10.203



AGAVE  
velo white  
40408.16.203

## KOMODO OMBRA 2 **new**

polipropilene fiberglass  
tessuto

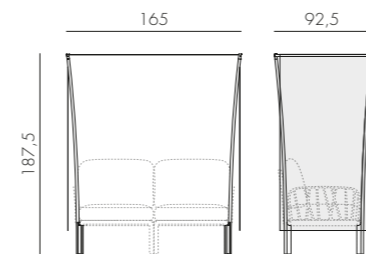

2,8 kg  
n. pz. 1

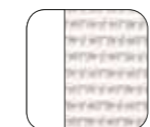

BIANCO  
velo white  
40407.00.203

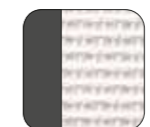

ANTRACITE  
velo white  
40407.02.203



TORTORA  
velo white  
40407.10.203



AGAVE  
velo white  
40407.16.203

# Variazioni di colore sono da ritenersi standard e naturali nei tessuti acrilici tinto filo. Posizionare in zone d'ombra - Colour variations are to be considered standard and natural in yarn-dyed acrylic fabrics. Position in shaded areas - Les variations de couleur des tissus acryliques au fil teint sont standard et naturelles. Placer dans des zones ombragées - Farbveränderungen sind als Standard und in im Garn gefärbten Acrylgeweben als natürlich zu betrachten. In schattigen Bereichen aufstellen - Las variaciones de color son normales y naturales en las telas acrílicas teñidas en hilo. Colocar en zonas de sombra - As variações de cor são consideradas standard e naturais nos tecidos acrílico tingidos com fio. Posicionar em zonas de sombra - Boyalı akrilik iplik kumaşlarda renk değişiklikleri standart ve doğal kabul edilir. Gölgeli alanlara yerleştiriniz - Изменения цвета следует считать нормой, они являются естественными в случае акриловых тканей с окрашенными волокнами. Размещать в тени

\* Trattamento laminato su richiesta con quantità minima - Laminated finish available on request with a minimum quantity - Traitement laminé sur demande avec une quantité minimum - Lamierte Ausrüstung auf Anfrage mit einer Mindestmenge - Tratamiento laminado bajo pedido con una cantidad mínima - Tratamento laminado sob encomenda com quantidade mínima - Talep üzerine minimum miktarda lamine işlem - Ламинированная обработка по запросу с минимальным количеством

## KOMODO BRACCIOLAIO

polipropilene fiberglass

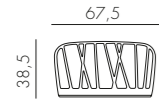

1,7 kg  
n. pz. 2



BIANCO  
40375.00.000

ANTRACITE  
40375.02.000

TORTORA  
40375.10.000

AGAVE  
40375.16.000

## KOMODO SCHIENALE

polipropilene fiberglass

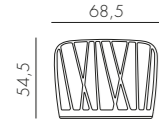

2 kg  
n. pz. 4



BIANCO  
40376.00.000

ANTRACITE  
40376.02.000

TORTORA  
40376.10.000

AGAVE  
40376.16.000

## CUSCINO SCHIENALE KOMODO

tessuto

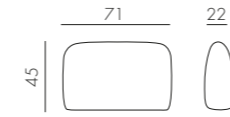

1,4 kg  
n. pz. 1



rosa quarzo #  
36370.52.066

grigio komodo  
36370.52.172

adriatic Sunbrella®\*  
36370.52.142

ghiaccio Sunbrella®\*  
36370.52.138

avocado Sunbrella®\*  
36370.52.139



giungla Sunbrella®\*  
36370.52.140

canvas Sunbrella®\*  
36370.52.141

TECH panama  
36370.52.131

Sunbrella® EXTRA  
pp 254

Nardi Acrilici/Acrylic  
pp. 252

## CUSCINO SCHIENALE ANGOLO KOMODO

tessuto

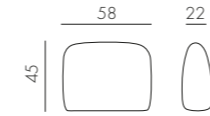

1,1 kg  
n. pz. 1



rosa quarzo #  
36370.54.066

grigio komodo  
36370.54.172

adriatic Sunbrella®\*  
36370.54.142

ghiaccio Sunbrella®\*  
36370.54.138

avocado Sunbrella®\*  
36370.54.139



giungla Sunbrella®\*  
36370.54.140

canvas Sunbrella®\*  
36370.54.141

TECH panama  
36370.54.131

Sunbrella® EXTRA ▲  
pp 254

Nardi Acrilici/Acrylic ▲  
pp. 252

### ▲ Sunbrella® EXTRA - pp. 254 Nardi Acrilici/Acrylic - pp. 252

Tessuti disponibili su ordinazione per minimi quantitativi d'ordine - Fabrics available to order for minimum order quantities - Tissus disponibles sur commande de quantités minimales - Gewebe auf Bestellung für Mindestbestellmengen erhältlich - Telas disponibles bajo pedido para cantidades mínimas - Tecidos disponíveis por encomenda para quantidades mínimas de encomenda - Minimum sipariş miktarına göre sipari verilebilecek mevcut kumaşlar - ткани на заказ для минимального объема заказа

# Variazioni di colore sono da ritenersi standard e naturali nei tessuti acrilici tinto filo. Posizionare in zone d'ombra - Colour variations are to be considered standard and natural in yarn-dyed acrylic fabrics. Position in shaded areas - Les variations de couleur des tissus acryliques au fil teint sont standard et naturelles. Placer dans des zones ombragées - Farbveränderungen sind als Standard und in im Garn gefärbten Acrylgeweben als natürlich zu betrachten. In schattigen Bereichen aufstellen - Las variaciones de color son normales y naturales en las telas acrílicas teñidas en hilo. Colocar en zonas de sombra - As variações de cor são consideradas standard e naturais nos tecidos acrílico tingidos com fio. Posicionar em zonas de sombra - Boyalı akrilik iplik kumaşlarda renk değişiklikleri standart ve doğal kabul edilir. Gölge alanlara yerleştiriniz - Изменения цвета следует считать нормой, они являются естественными в случае акриловых тканей с окрашенными волокнами. Размещать в тени

\* Trattamento laminato su richiesta con quantità minima - Laminated finish available on request with a minimum quantity - Traitement laminé sur demande avec une quantité minimum - Lamierte Ausrüstung auf Anfrage mit einer Mindestmenge - Tratamiento laminado bajo pedido con una cantidad mínima - Tratamiento laminado sob encomenda com quantidade mínima - Talep üzerine minimum miktarda lamine işlem - Ламинированная обработка по запросу с минимальным количеством



DOGA RELAX **new**

polipropilene fiberglass

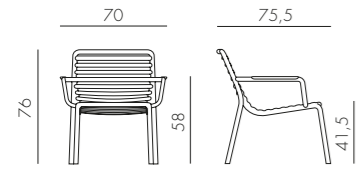

6,1 kg  
n. pz. 4



BIANCO 40256.00.000 ANTRACITE 40256.02.000 CAPPUCCINO 40256.14.000 MENTA 40256.15.000 AGAVE 40256.16.000 PERA 40256.18.000



MARSALA 40256.21.000 TABACCO 40256.53.000

DOGA BISTROT **new**

polipropilene fiberglass

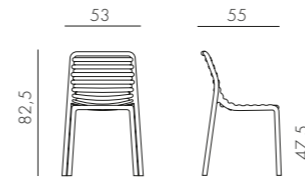

4 kg  
n. pz. 6



BIANCO 40255.00.000 ANTRACITE 40255.02.000 CAPPUCCINO 40255.14.000 MENTA 40255.15.000 AGAVE 40255.16.000 PERA 40255.18.000



MARSALA 40255.21.000 TABACCO 40255.53.000

DOGA ARMCHAIR **new**

polipropilene fiberglass

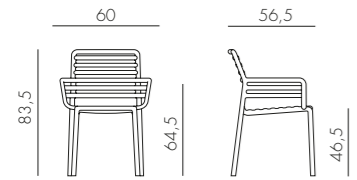

4,8 kg  
n. pz. 6



BIANCO 40254.00.000 ANTRACITE 40254.02.000 CAPPUCCINO 40254.14.000 MENTA 40254.15.000 AGAVE 40254.16.000 PERA 40254.18.000



MARSALA 40254.21.000 TABACCO 40254.53.000

## TRILL ARMCHAIR



polipropilene fiberglass

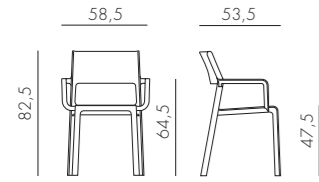

4,7 kg  
n. pz. 6



BIANCO 40250.00.000 ANTRACITE 40250.02.000 GRIGIO 40250.03.000 ROSA BOUQUET 40250.08.000 TORTORA 40250.10.000 AGAVE 40250.16.000



OTTANIO 40250.49.000 TABACCO 40250.53.000 SENAPE 40250.56.000

## TRILL BISTROT

polipropilene fiberglass

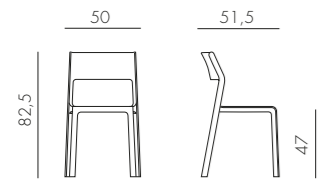

4,2 kg  
n. pz. 6



BIANCO 40253.00.000 ANTRACITE 40253.02.000 GRIGIO 40253.03.000 ROSA BOUQUET 40253.08.000 TORTORA 40253.10.000 AGAVE 40253.16.000



OTTANIO 40253.49.000 TABACCO 40253.53.000 SENAPE 40253.56.000

## TRILL STOOL

polipropilene fiberglass

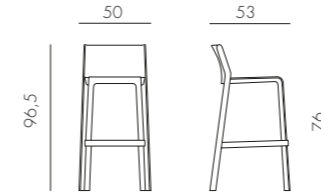

5,1 kg  
n. pz. 4



BIANCO 40350.00.000 ANTRACITE 40350.02.000 GRIGIO 40350.03.000 ROSA BOUQUET 40350.08.000 TORTORA 40350.10.000 AGAVE 40350.16.000



OTTANIO 40350.49.000 TABACCO 40350.53.000 SENAPE 40350.56.000

## TRILL STOOL MINI

polipropilene fiberglass

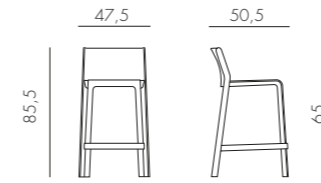

4,8 kg  
n. pz. 4



BIANCO 40353.00.000 ANTRACITE 40353.02.000 GRIGIO 40353.03.000 ROSA BOUQUET 40353.08.000 TORTORA 40353.10.000 AGAVE 40353.16.000



OTTANIO 40353.49.000 TABACCO 40353.53.000 SENAPE 40353.56.000



### Life Cycle Assessment

For more information visit [www.nardioutdoor.com/sustainability](http://www.nardioutdoor.com/sustainability)

## NET BENCH

polipropilene fiberglass

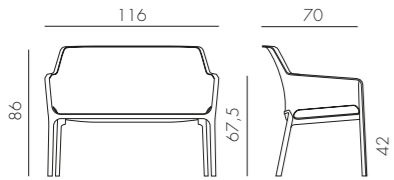

8,9 kg  
n. pz. 20



BIANCO 40338.00.000 ANTRACITE 40338.02.000 SALICE 40338.04.000 TORTORA 40338.10.000 SENAPE 40338.56.000 CORALLO 40338.75.000

## NET STOOL

polipropilene fiberglass

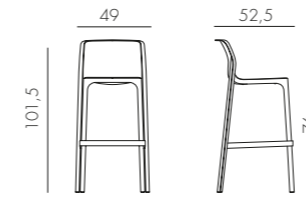

4,4 kg  
n. pz. 4



BIANCO 40355.00.000 ANTRACITE 40355.02.000 SALICE 40355.04.000 TORTORA 40355.10.000 SENAPE 40355.56.000 CORALLO 40355.75.000

## NET RELAX

polipropilene fiberglass

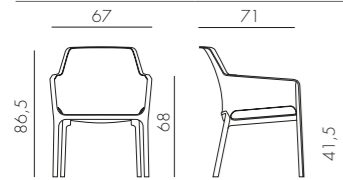

4,9 kg  
n. pz. 4



pz. 6



BIANCO 40327.00.000 ANTRACITE 40327.02.000 SALICE 40327.04.000 TORTORA 40327.10.000 SENAPE 40327.56.000 CORALLO 40327.75.000

## NET STOOL MINI

polipropilene fiberglass

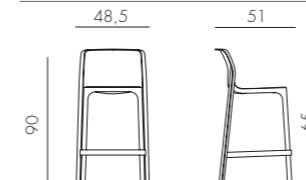

4,2 kg  
n. pz. 4



BIANCO 40356.00.000 ANTRACITE 40356.02.000 SALICE 40356.04.000 TORTORA 40356.10.000 SENAPE 40356.56.000 CORALLO 40356.75.000

## NET

polipropilene fiberglass

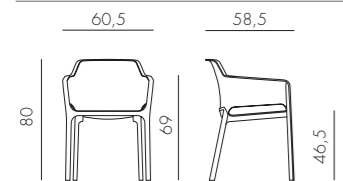

3,9 kg  
n. pz. 6



pz. 6



BIANCO 40326.00.000.06 ANTRACITE 40326.02.000.06 SALICE 40326.04.000.06 TORTORA 40326.10.000.06 SENAPE 40326.56.000.06 CORALLO 40326.75.000.06

## BIT

polipropilene fiberglass

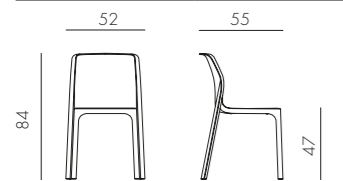

3,5 kg  
n. pz. 6



BIANCO 40328.00.000.06 ANTRACITE 40328.02.000.06 SALICE 40328.04.000.06 TORTORA 40328.10.000.06 SENAPE 40328.56.000.06 CORALLO 40328.75.000.06

## BORA

polipropilene fiberglass

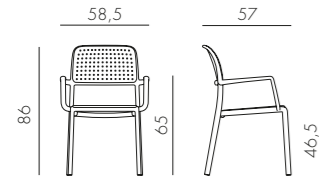

4,4 kg  
n. pz. 6  pz. 6



BIANCO 40242.00.000.06 ANTRACITE 40242.02.000.06 CAFFÈ 40242.05.000.06 ROSSO 40242.07.000.06 TORTORA 40242.10.000.06 AGAVE 40242.16.000.06 CELESTE 40242.39.000.06

## COSTA

polipropilene fiberglass

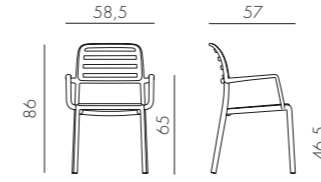

4,5 kg  
n. pz. 6  pz. 6



BIANCO 40244.00.000.06 ANTRACITE 40244.02.000.06 CAFFÈ 40244.05.000.06 ROSSO 40244.07.000.06 TORTORA 40244.10.000.06 AGAVE 40244.16.000.06 CELESTE 40244.39.000.06

## BORA BISTROT

polipropilene fiberglass

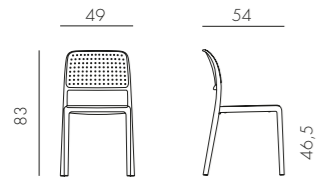

3,7 kg  
n. pz. 6  pz. 6



BIANCO 40243.00.000.06 ANTRACITE 40243.02.000.06 CAFFÈ 40243.05.000.06 ROSSO 40243.07.000.06 TORTORA 40243.10.000.06 AGAVE 40243.16.000.06 CELESTE 40243.39.000.06

## COSTA BISTROT

polipropilene fiberglass

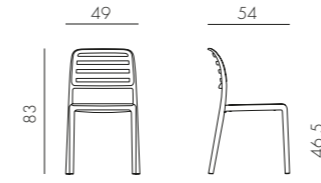

3,9 kg  
n. pz. 6  pz. 6



BIANCO 40245.00.000.06 ANTRACITE 40245.02.000.06 CAFFÈ 40245.05.000.06 ROSSO 40245.07.000.06 TORTORA 40245.10.000.06 AGAVE 40245.16.000.06 CELESTE 40245.39.000.06

## RIVA

polipropilene fiberglass

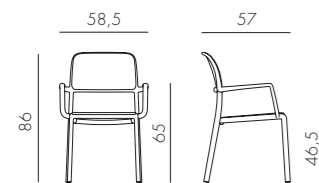

4,6 kg  
n. pz. 6  pz. 6



BIANCO 40246.00.000.06 ANTRACITE 40246.02.000.06 CAFFÈ 40246.05.000.06 ROSSO 40246.07.000.06 TORTORA 40246.10.000.06 AGAVE 40246.16.000.06 CELESTE 40246.39.000.06

## LIDO

polipropilene fiberglass

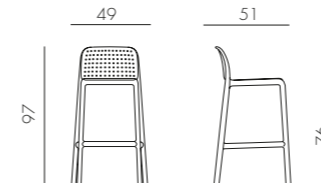

4,3 kg  
n. pz. 4 



BIANCO 40344.00.000 ANTRACITE 40344.02.000 CAFFÈ 40344.05.000 ROSSO 40344.07.000 TORTORA 40344.10.000 AGAVE 40344.16.000 CELESTE 40344.39.000

## RIVA BISTROT

polipropilene fiberglass

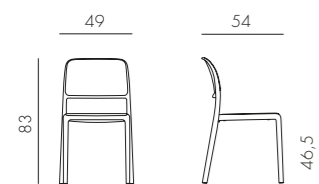

4 kg  
n. pz. 6  pz. 6



BIANCO 40247.00.000.06 ANTRACITE 40247.02.000.06 CAFFÈ 40247.05.000.06 ROSSO 40247.07.000.06 TORTORA 40247.10.000.06 AGAVE 40247.16.000.06 CELESTE 40247.39.000.06

## LIDO MINI

polipropilene fiberglass

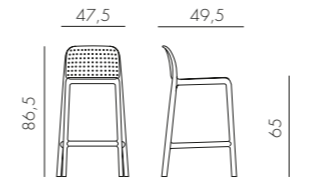

3,9 kg  
n. pz. 4 



BIANCO 40345.00.000 ANTRACITE 40345.02.000 CAFFÈ 40345.05.000 ROSSO 40345.07.000 TORTORA 40345.10.000 AGAVE 40345.16.000 CELESTE 40345.39.000

## FARO

polipropilene fiberglass

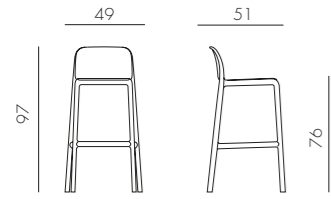

4,5 kg  
n. pz. 4



BIANCO 40346.00.000 ANTRACITE 40346.02.000 CAFFÈ 40346.05.000 ROSSO 40346.07.000 TORTORA 40346.10.000 AGAVE 40346.16.000 CELESTE 40346.39.000

## PALMA

polipropilene

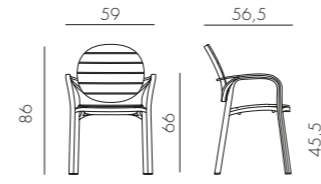

5,2 kg  
n. pz. 6



BIANCO 40237.00.000 BIANCO TORTORA 40237.00.010 ANTRACITE 40237.02.002 CAFFÈ 40237.05.005 TORTORA 40237.10.010

## FARO MINI

polipropilene fiberglass

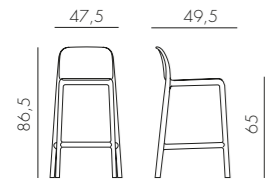

4 kg  
n. pz. 4



BIANCO 40347.00.000 ANTRACITE 40347.02.000 CAFFÈ 40347.05.000 ROSSO 40347.07.000 TORTORA 40347.10.000 AGAVE 40347.16.000 CELESTE 40347.39.000

## ERICA

polipropilene

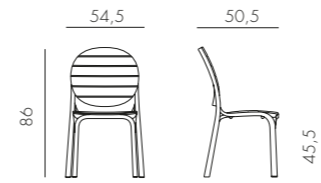

4,2 kg  
n. pz. 22



BIANCO 40236.00.000 BIANCO TORTORA 40236.00.010 ANTRACITE 40236.02.002 CAFFÈ 40236.05.005 TORTORA 40236.10.010

## ACQUAMARINA

polipropilene fiberglass

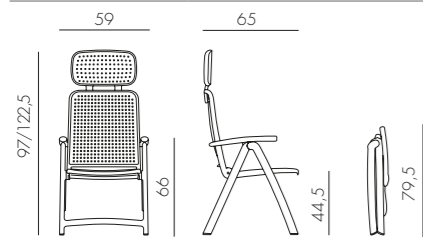

8 kg  
n. pz. 1



BIANCO 40314.00.000 ANTRACITE 40314.02.000 CAFFÈ 40314.05.000 TORTORA 40314.10.000

## GARDENIA

polipropilene

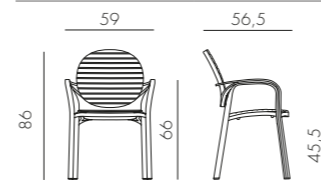

5,2 kg  
n. pz. 6



BIANCO 40238.00.000 BIANCO TORTORA 40238.00.010 ANTRACITE 40238.02.002 CAFFÈ 40238.05.005 TORTORA 40238.10.010

## DARSENA

polipropilene fiberglass

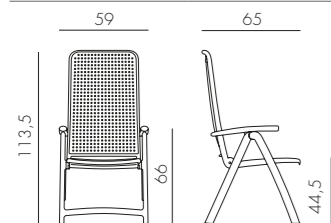

7,7 kg  
n. pz. 1



BIANCO 40316.00.000 ANTRACITE 40316.02.000 CAFFÈ 40316.05.000 TORTORA 40316.10.000

## DALIA

polipropilene

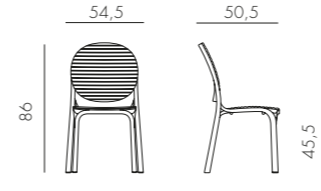

4,2 kg  
n. pz. 22



BIANCO 40239.00.000 BIANCO TORTORA 40239.00.010 ANTRACITE 40239.02.002 CAFFÈ 40239.05.005 TORTORA 40239.10.010

## ARIA (POLTRONA ARIA + CUSCINO SEDUTA + CUSCINO ARREDO)

polipropilene  
tessuto

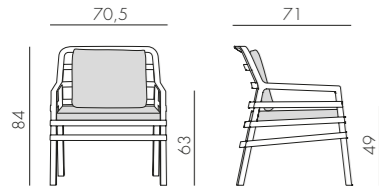

7,9 kg  
n. pz. 1

\* Disponibile a magazzino  
Available ex-stock  
Disponibile sur stock  
Ab Lager verfügbar  
Disponibile en almacén habitualmente  
Disponível em estoque  
Stokta mevcut  
Наличие на складе

\* Disponibile su ordine  
Available to order  
Disponibile sur commande  
Mit Auftrag verfügbar  
Disponibile sólo sobre pedido  
Disponível sob encomenda  
Sipariş göre hazırlanacaktır  
Под заказ



## ARIA FIT (POLTRONA ARIA + CUSCINO SEDUTA + CUSCINO FIT)

polipropilene  
tessuto

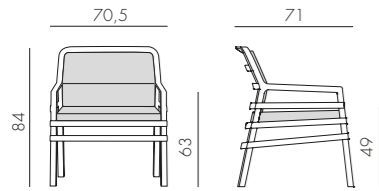

7,9 kg  
n. pz. 1

\* Disponibile su ordine  
Available to order  
Disponibile sur commande  
Mit Auftrag verfügbar  
Disponibile sólo sobre pedido  
Disponível sob encomenda  
Sipariş göre hazırlanacaktır  
Под заказ

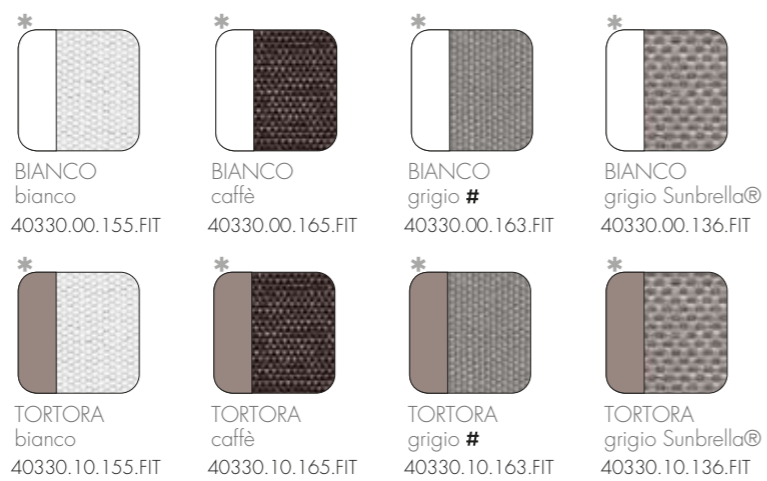

## NINFEA DINNER

polipropilene  
alluminio

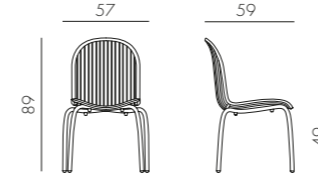

4,5 kg  
n. pz. 6



ANTRACITE  
verniciato antracite  
62052.02.000

BIANCO  
verniciato bianco  
62053.00.000

## NINFEA RELAX

polipropilene  
alluminio

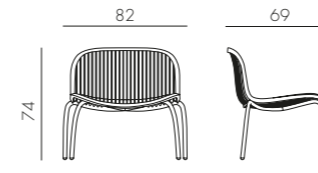

7,2 kg  
n. pz. 2



ANTRACITE  
verniciato antracite  
62252.02.000

BIANCO  
verniciato bianco  
62253.00.000

## MUSA

polipropilene  
alluminio

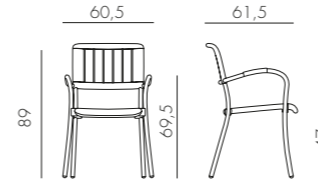

4,2 kg  
n. pz. 24



ANTRACITE  
verniciato antracite  
61052.02.000

TORTORA  
verniciato tortora  
61059.10.000

# Variazioni di colore sono da ritenersi standard e naturali nei tessuti acrilici tinto filo. Posizionare in zone d'ombra - Colour variations are to be considered standard and natural in yarn-dyed acrylic fabrics. Position in shaded areas - Les variations de couleur des tissus acryliques au fil teint sont standard et naturelles. Placer dans des zones ombragées - Farbveränderungen sind als Standard und in im Garn gefärbten Acrylgeweben als natürlich zu betrachten. In schattigen Bereichen aufstellen - Las variaciones de color son normales y naturales en las telas acrílicas teñidas en hilo. Colocar en zonas de sombra - As variações de cor são consideradas standard e naturais nos tecidos acrílico tingidos com fio. Posicionar em zonas de sombra - Boyalı akrilik iplik kumaşlarda renk değişiklikleri standart ve doğal kabul edilir. Gölge alanlara yerleştiriniz - Изменения цвета следует считать нормой, они являются естественными в случае акриловых тканей с окрашенными волокнами. Размещать в тени

## ATLANTICO

polipropilene fiberglass  
tessuto sintetico

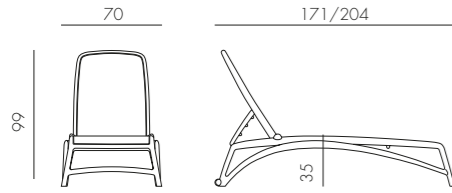

16 kg  
n. pz. 20

Tessuto ricambiabile  
Replaceable fabric  
Tissu changeable  
Auswechselbarer Stoff  
Tela sustituible  
Tecidos recambiáveis  
Değiştirilebilen Kumaş  
Съемная ткань

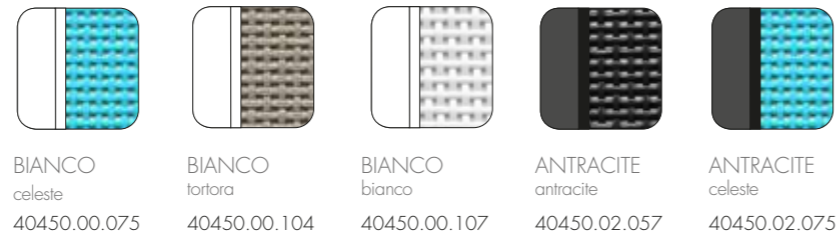

## BRACCIOLO ATLANTICO

polipropilene fiberglass

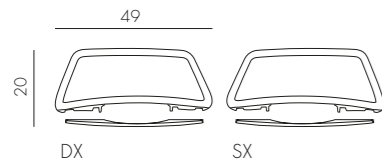

1,1 kg  
n. pz. 1  
1 KIT = 2 pz (1DX+1SX)

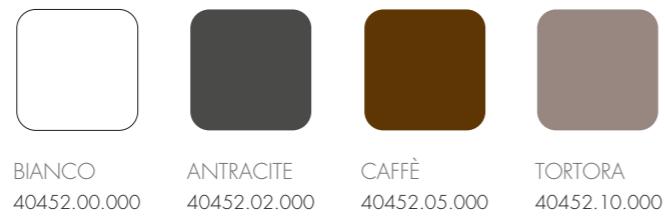

## RICAMBIO ATLANTICO

resina acetlica  
tessuto sintetico

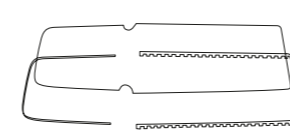

1,3 kg  
n. pz. 1

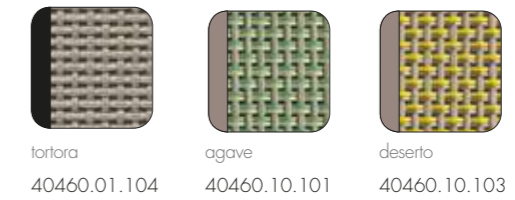
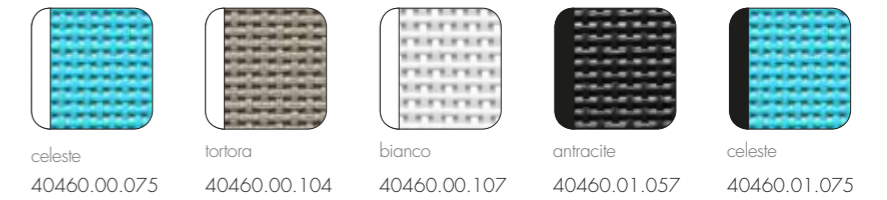

## ALFA

polipropilene  
tessuto sintetico

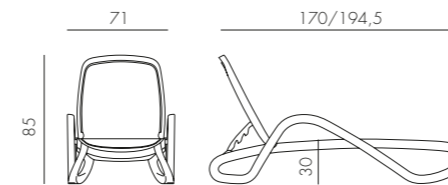

14 kg  
n. pz. 17

Tessuto ricambiabile  
Replaceable fabric  
Tissu changeable  
Auswechselbarer Stoff  
Tela sustituible  
Tecidos recambiáveis  
Değiştirilebilen Kumaş  
Съемная ткань

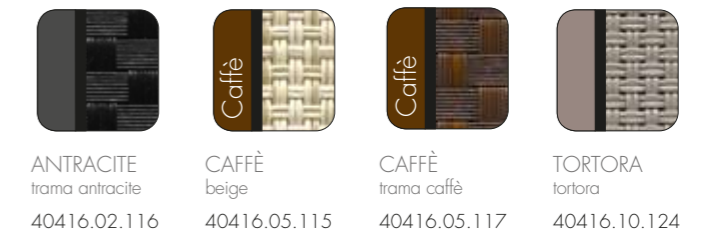
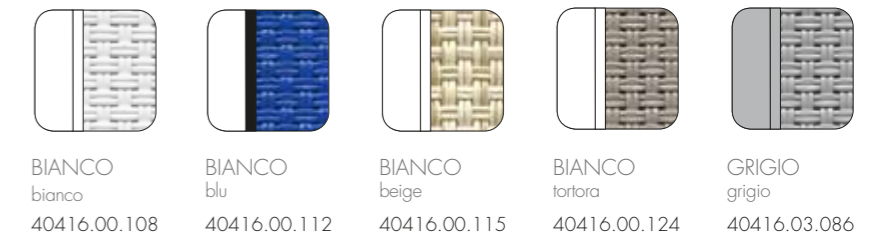

## OMEGA

polipropilene  
tessuto sintetico

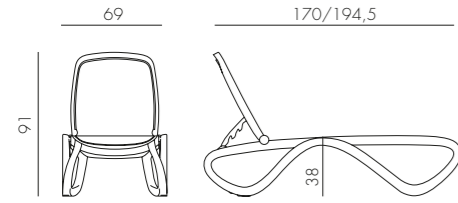

14,3 kg  
n. pz. 18



Tessuto ricambiabile  
Replaceable fabric  
Tissu changeable  
Auswechselbarer Stoff  
Tela substituible  
Tecidos recambiáveis  
Değiştirilebilen Kumaş  
Съемная ткань

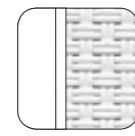

BIANCO  
bianco  
40417.00.108



BIANCO  
blu  
40417.00.112

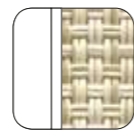

BIANCO  
beige  
40417.00.115

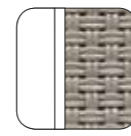

BIANCO  
tortora  
40417.00.124

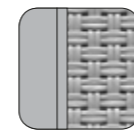

GRIGIO  
grigio  
40417.03.086

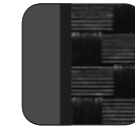

ANTRACITE  
trama antracite  
40417.02.116



CAFFÈ  
beige  
40417.05.115



CAFFÈ  
trama caffè  
40417.05.117



TORTORA  
tortora  
40417.10.124

## RICAMBIO

ALFA - OMEGA

resina acetilica  
tessuto sintetico

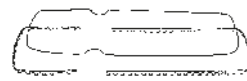

1,6 kg  
n. pz. 1

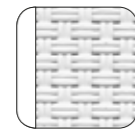

bianco  
40424.00.108

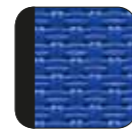

blu  
40424.00.112



beige  
40424.01.115



tortora  
40424.00.124

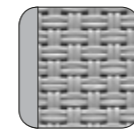

grigio  
40424.03.086



tortora  
40424.01.124



beige  
40424.00.115

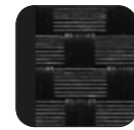

trama antracite  
40424.00.116



trama caffè  
40424.00.117

## EDEN

polipropilene

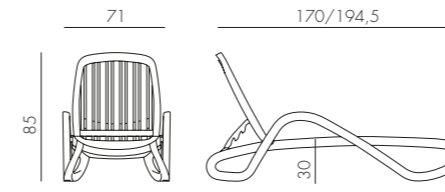

14,7 kg  
n. pz. 17

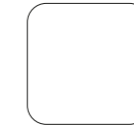

BIANCO  
40414.00.000



TORTORA  
40414.10.000

## TROPICO

polipropilene

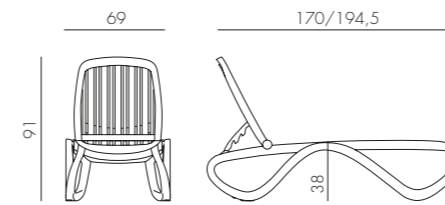

15,1 kg  
n. pz. 18



BIANCO  
40413.00.000



TORTORA  
40413.10.000

## PARASOLE

ALFA - OMEGA - EDEN - TROPICO

polipropilene  
tessuto sintetico

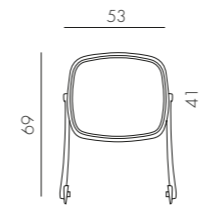

1,4 kg  
n. pz. 1

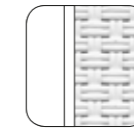

BIANCO  
bianco  
40418.00.108

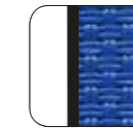

BIANCO  
blu  
40418.00.112

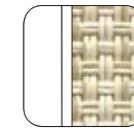

BIANCO  
beige  
40418.00.115

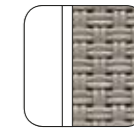

BIANCO  
tortora  
40418.00.124

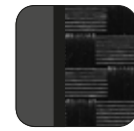

ANTRACITE  
trama antracite  
40418.02.116



CAFFÈ  
beige  
40418.05.115



CAFFÈ  
trama caffè  
40418.05.117



TORTORA  
tortora  
40418.10.124



## CLIP 80

durelTOP  
polipropilene fiberglass

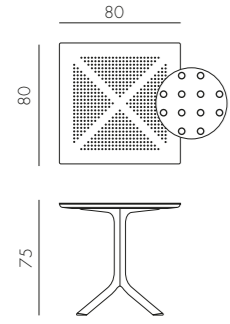

12,1 kg  
n. pz. 1



BIANCO 40082.00.000  
ANTRACITE \* 40082.02.000  
TORTORA 40082.10.000  
AGAVE 40082.16.000  
TABACCO \* 40082.53.000

## CLIP 70

durelTOP  
polipropilene fiberglass

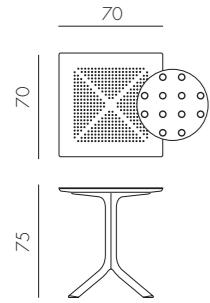

11 kg  
n. pz. 1



BIANCO 40084.00.000  
ANTRACITE \* 40084.02.000  
TORTORA 40084.10.000  
AGAVE 40084.16.000  
TABACCO \* 40084.53.000

## CLIPX 80

durelTOP  
polipropilene fiberglass

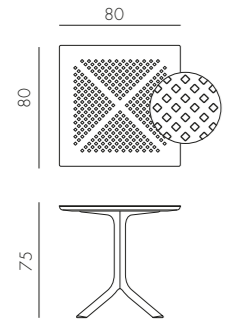

11,7 kg  
n. pz. 1



BIANCO 40083.00.000  
ANTRACITE \* 40083.02.000  
TORTORA 40083.10.000

## CLIPX 70

durelTOP  
polipropilene fiberglass

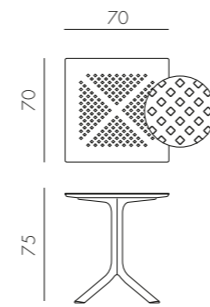

10,7 kg  
n. pz. 1



BIANCO 40085.00.000  
ANTRACITE \* 40085.02.000  
TORTORA 40085.10.000

## BASE CLIP

PIANI Ø80 - 70X70 - 80X80

polipropilene fiberglass

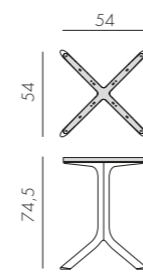

8,1 kg  
n. pz. 1



BIANCO 40088.00.000  
ANTRACITE 40088.02.000  
TORTORA 40088.10.000  
AGAVE 40088.16.000  
TABACCO 40088.53.000

\* Posizionare in zone d'ombra - Position in shaded areas - Placer dans des zones ombragées - In schattigen Bereichen aufstellen - Colocar en zonas de sombra - Posicionar em zonas de sombra - Gölğeli alanlara yerleştiriniz - Размещать в тени

\* Posizionare in zone d'ombra - Position in shaded areas - Placer dans des zones ombragées - In schattigen Bereichen aufstellen - Colocar en zonas de sombra - Posicionar em zonas de sombra - Gölğeli alanlara yerleştiriniz - Размещать в тени

## STEP

polipropilene fiberglass

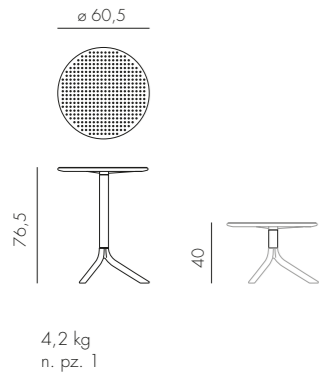

## SPRITZ

polipropilene fiberglass

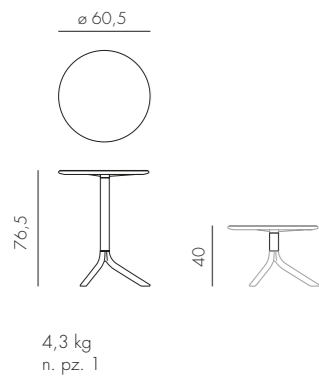

## DOGA TABLE **new**

polipropilene fiberglass



## NET TABLE 100

polipropilene fiberglass

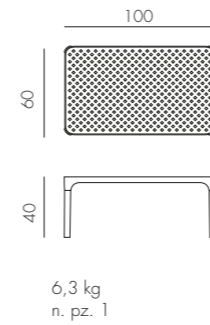

## ARIA TAVOLINO 100

polipropilene

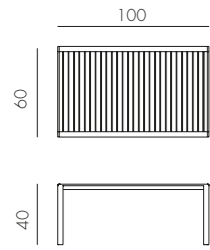

BIANCO  
40052.00.000

TORTORA  
40052.10.000

8 kg  
n. pz. 1

## ARIA TAVOLINO 60

polipropilene

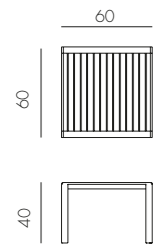

BIANCO  
40051.00.000

TORTORA  
40051.10.000

5 kg  
n. pz. 1

## POP

polipropilene fiberglass

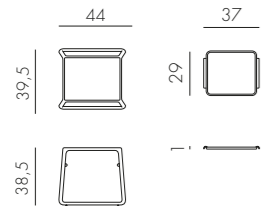

BIANCO  
40048.00.000

ANTRACITE  
40048.02.000

CAFFÈ  
40048.05.000

TORTORA  
40048.10.000

2,5 kg  
n. pz. 4



## MAESTRALE 90

durelTOP - polipropilene  
alluminio

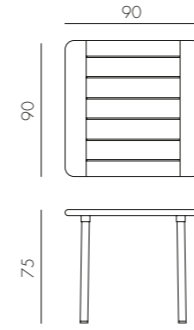

ANTRACITE \*  
verniciato antracite  
42052.02.000

TORTORA  
verniciato tortora  
42059.10.000

12 kg  
n. pz. 1



## LOTO RELAX 95

vetro  
alluminio

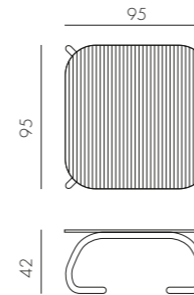

ANTRACITE  
verniciato antracite  
44752.02.000

BIANCO  
verniciato bianco  
44753.00.000

27 kg  
n. pz. 1

## LOTO RELAX 60

laminato  
alluminio

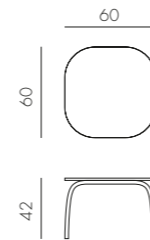

ANTRACITE \*  
verniciato antracite  
44652.10.303

BIANCO  
verniciato bianco  
44653.10.301

5 kg  
n. pz. 1

\* Posizionare in zone d'ombra - Position in shaded areas - Placer dans des zones ombragées - In schattigen Bereichen aufstellen - Colocar en zonas de sombra - Posicionar em zonas de sombra - Gölğeli alanlara yerleştiriniz - Размещать в тени

## CUBE 140X80

durelTOP - polipropilene  
alluminio

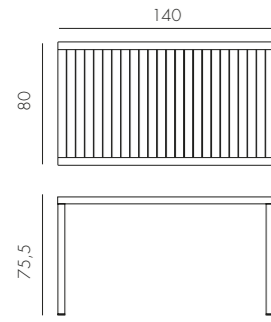

BIANCO verniciato bianco 47753.00.000	ANTRACITE * verniciato antracite 47752.02.000	CAFFÈ * verniciato caffè 47757.05.000	TORTORA verniciato tortora 47759.10.000
---	---	---	---

16,9 kg  
n. pz. 1

## CUBE 80

durelTOP - polipropilene  
alluminio

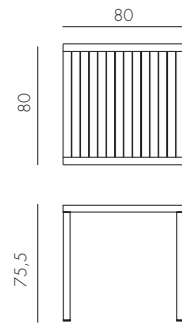

BIANCO verniciato bianco 48053.00.000	ANTRACITE verniciato antracite 48052.02.000	CAFFÈ verniciato caffè 48057.05.000	TORTORA verniciato tortora 48059.10.000
---	---	---	---

11,5 kg  
n. pz. 1

## CUBE 70

durelTOP - polipropilene  
alluminio

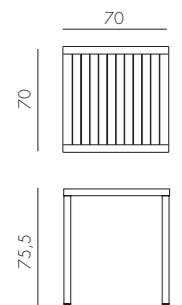

BIANCO verniciato bianco 47853.00.000	ANTRACITE verniciato antracite 47852.02.000	CAFFÈ verniciato caffè 47857.05.000	TORTORA verniciato tortora 47859.10.000
---	---	---	---

9,5 kg  
n. pz. 1

## KIT CUBE 140X80 HIGH

alluminio

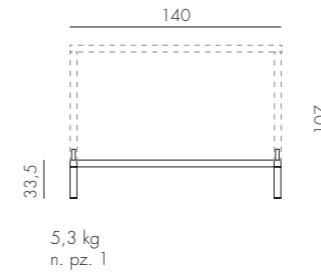

verniciato bianco 46953.00.000	verniciato antracite 46952.02.000	verniciato caffè 46957.05.000	verniciato tortora 46959.10.000
-----------------------------------	--------------------------------------	----------------------------------	------------------------------------

5,3 kg  
n. pz. 1

## KIT CUBE 80 HIGH

alluminio

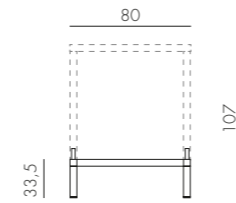

verniciato bianco 48153.00.000	verniciato antracite 48152.02.000	verniciato caffè 48157.05.000	verniciato tortora 48159.10.000
-----------------------------------	--------------------------------------	----------------------------------	------------------------------------

4,2 kg  
n. pz. 1

## KIT CUBE 70 HIGH

alluminio

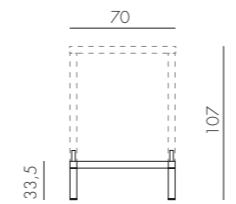

verniciato bianco 47953.00.000	verniciato antracite 47952.02.000	verniciato caffè 47957.05.000	verniciato tortora 47959.10.000
-----------------------------------	--------------------------------------	----------------------------------	------------------------------------

4 kg  
n. pz. 1

\* Posizionare in zone d'ombra - Position in shaded areas - Placer dans des zones ombragées - In schattigen Bereichen aufstellen - Colocar en zonas de sombra - Posicionar em zonas de sombra - Gölge alanlara yerleştiriniz - Размещать в тени

## BASE FRASCA MAXI FIX

PIANI Ø80 - Ø90 - Ø100 ● - 80X80 - 90X90 - 100X100 ●

alluminio

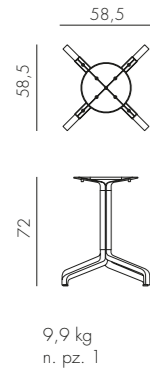

## BASE FRASCA MINI FIX

PIANI Ø60 - Ø70 - Ø80 - 60X60 - 70X70 - 80X80

alluminio

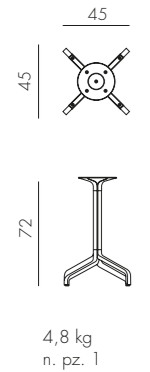

## BASE FRASCA MINI FOLDING

PIANI Ø60 - Ø70 - Ø80 - 60X60 - 70X70 - 80X80

alluminio

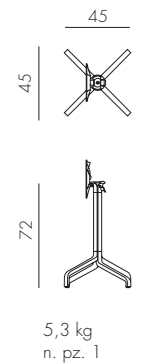

● solo su richiesta - only on request - uniquement sur demande - Nur auf Anfrage - sólo bajo pedido - apenas sob encomenda - sadece istek üzerine - только по запросу

■ trattamento speciale per ambienti ad alto tasso salino - special treatment for high salinity environments - traitement spécial pour les environnements a haute salinité - Sonderbehandlung für Ambiente mit hohem Salzgehalt - tratamiento especial para ambientes con alta salinidad - tratamento especial para ambientes com alto teor de sal - yüksek tuza maruz kalan alanlar için özel bakım - Специальная обработка для среды с высоким содержанием соли

La garanzia è valida solo se la base è utilizzata con i piani della collezione Nardi - The guarantee is valid only if the base is used with Nardi collection tops - La garantie est valide uniquement si la base est utilisée avec les plateaux de la collection Nardi - Die Garantie gilt nur, wenn die Gestelle mit den Tischplatten der Nardi-Kollektion verwendet wird - La garantía es válida solo si la base se utiliza con los tableros de la colección Nardi - A garantia só é válida se a base for utilizada com os tampo da coleção Nardi - Garanti sadece Nardi masa tablası ile ayağının birlikte kullanılması durumunda geçerlidir - Гарантия действует только при использовании базы с топами коллекции Nardi.

Qualora il prodotto venga posizionato in ambienti altamente salini raccomandiamo di scegliere una base con trattamento speciale. If the product is placed in highly salty environments, we recommend choosing a base with a special treatment. Si le produit est placé dans des environnements a haute salinite, nous recommandons de choisir une base avec un traitement spécial. Wenn das Produkt in der Umgebung mit hohem Salzgehalt platziert ist, empfehlen wir, eine Basis mit Sonderbehandlung zu wählen. Si el producto se coloca en ambientes con alta salinidad, recomendamos elegir una base con un tratamiento especial. Se o produto for exposto em ambientes com alto teor de salinidade, recomendamos a escolha de uma base com tratamento especial. Ürünün, salinitesi yüksek olan ortamlarda kullanılması durumunda, özel muamele görmüş versiyonun seçilmesi tavsiye olunur. Если изделие будет использоваться в среде с высоким содержанием соли, рекомендуется выбрать основание со специальной обработкой.

## BASE FRASCA HIGH FIX **new**

PIANI Ø60 - Ø70 - 60X60 - 70X70

alluminio

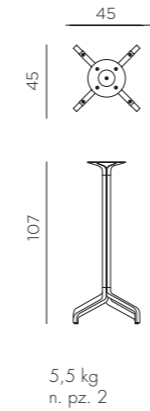

## BASE FRASCA HIGH FOLDING **new**

PIANI Ø60 - Ø70 - 60X60 - 70X70

alluminio

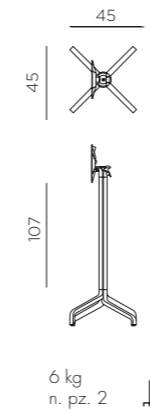

6 kg  
n. pz. 2

■ trattamento speciale per ambienti ad alto tasso salino - special treatment for high salinity environments - traitement spécial pour les environnements a haute salinité - Sonderbehandlung für Ambiente mit hohem Salzgehalt - tratamiento especial para ambientes con alta salinidad - tratamento especial para ambientes com alto teor de sal - yüksek tuza maruz kalan alanlar için özel bakım - Специальная обработка для среды с высоким содержанием соли

La garanzia è valida solo se la base è utilizzata con i piani della collezione Nardi - The guarantee is valid only if the base is used with Nardi collection tops - La garantie est valide uniquement si la base est utilisée avec les plateaux de la collection Nardi - Die Garantie gilt nur, wenn die Gestelle mit den Tischplatten der Nardi-Kollektion verwendet wird - La garantía es válida solo si la base se utiliza con los tableros de la colección Nardi - A garantia só é válida se a base for utilizada com os tampo da coleção Nardi - Garanti sadece Nardi masa tablası ile ayağının birlikte kullanılması durumunda geçerlidir - Гарантия действует только при использовании базы с топами коллекции Nardi.

Qualora il prodotto venga posizionato in ambienti altamente salini raccomandiamo di scegliere una base con trattamento speciale. If the product is placed in highly salty environments, we recommend choosing a base with a special treatment. Si le produit est placé dans des environnements a haute salinite, nous recommandons de choisir une base avec un traitement spécial. Wenn das Produkt in der Umgebung mit hohem Salzgehalt platziert ist, empfehlen wir, eine Basis mit Sonderbehandlung zu wählen. Si el producto se coloca en ambientes con alta salinidad, recomendamos elegir una base con un tratamiento especial. Se o produto for exposto em ambientes com alto teor de salinidade, recomendamos a escolha de uma base com tratamento especial. Ürünün, salinitesi yüksek olan ortamlarda kullanılması durumunda, özel muamele görmüş versiyonun seçilmesi tavsiye olunur. Если изделие будет использоваться в среде с высоким содержанием соли, рекомендуется выбрать основание со специальной обработкой.

## BASE IBISCO

PIANI Ø60 - Ø70 - Ø80 - 60X60 - 70X70 - 80X80

alluminio

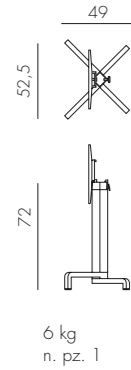

6 kg  
n. pz. 1

## BASE IBISCO HIGH

PIANI Ø60 - Ø70 - 60X60 - 70X70

alluminio

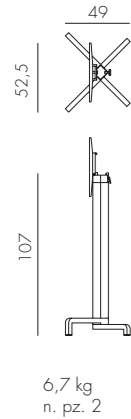

6,7 kg  
n. pz. 2

## BASE FIORE

PIANI Ø60 - Ø70 - Ø80 - 60X60 - 70X70 - 80X80

alluminio

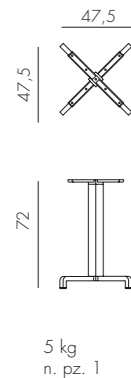

5 kg  
n. pz. 1

■ trattamento speciale per ambienti ad alto tasso salino - special treatment for high salinity environments - traitement spécial pour les environnements a haute salinité - Sonderbehandlung für Ambiente mit hohem Salzgehalt - tratamiento especial para ambientes con alta salinidad - tratamiento especial para ambientes con alto teor de sal - yüksek tuza maruz kalan alanlar için özel bakım - Специальная обработка для среды с высоким содержанием соли

Qualora il prodotto venga posizionato in ambienti altamente salini raccomandiamo di scegliere una base con trattamento speciale. If the product is placed in highly salty environments, we recommend choosing a base with a special treatment. Si le produit est placé dans des environnements a haute salinite, nous recommandons de choisir une base avec un traitement spécial. Wenn das Produkt in der Umgebung mit hohem Salzgehalt platziert ist, empfehlen wir, eine Basis mit Sonderbehandlung zu wählen. Si el producto se coloca en ambientes con alta salinidad, recomendamos elegir una base con un tratamiento especial. Se o produto for exposto em ambientes com alto teor de salinidade, recomendamos a escolha de uma base com tratamento especial. Ürünün, salinitesi yüksek olan ortamlarda kullanılması durumunda, özel muamele görmüş versiyonun seçilmesi tavsiye olunur. Если изделие будет использоваться в среде с высоким содержанием соли, рекомендуется выбрать основание со специальной обработкой.

## BASE FIORE HIGH

PIANI Ø60 - Ø70 - 60X60 - 70X70

alluminio

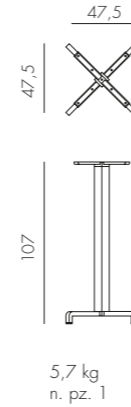

5,7 kg  
n. pz. 1

## BASE SCUDO

PIANI Ø60 - Ø70 - Ø80 - 60X60 - 70X70 - 80X80

alluminio



5,8 kg  
n. pz. 1

## BASE SCUDO HIGH

PIANI Ø60 - Ø70 - 60X60 - 70X70

alluminio

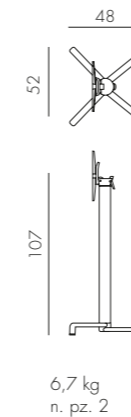

6,7 kg  
n. pz. 2

■ trattamento speciale per ambienti ad alto tasso salino - special treatment for high salinity environments - traitement spécial pour les environnements a haute salinité - Sonderbehandlung für Ambiente mit hohem Salzgehalt - tratamiento especial para ambientes con alta salinidad - tratamiento especial para ambientes con alto teor de sal - yüksek tuza maruz kalan alanlar için özel bakım - Специальная обработка для среды с высоким содержанием соли

Qualora il prodotto venga posizionato in ambienti altamente salini raccomandiamo di scegliere una base con trattamento speciale. If the product is placed in highly salty environments, we recommend choosing a base with a special treatment. Si le produit est placé dans des environnements a haute salinite, nous recommandons de choisir une base avec un traitement spécial. Wenn das Produkt in der Umgebung mit hohem Salzgehalt platziert ist, empfehlen wir, eine Basis mit Sonderbehandlung zu wählen. Si el producto se coloca en ambientes con alta salinidad, recomendamos elegir una base con un tratamiento especial. Se o produto for exposto em ambientes com alto teor de salinidade, recomendamos a escolha de uma base com tratamento especial. Ürünün, salinitesi yüksek olan ortamlarda kullanılması durumunda, özel muamele görmüş versiyonun seçilmesi tavsiye olunur. Если изделие будет использоваться в среде с высоким содержанием соли, рекомендуется выбрать основание со специальной обработкой.

## BASE SCUDO DOUBLE PIANI 110X170 - 120X80

alluminio

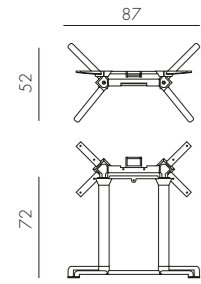

8,7 kg  
n. pz. 1

## BASE CALICE ALU

PIANI Ø60 - Ø70 - Ø80 - 60X60 - 70X70 - 80X80

alluminio

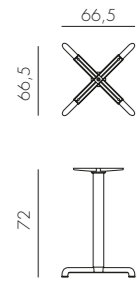

4,5 kg  
n. pz. 1

## BASE CALICE ALU HIGH PIANI Ø60 - Ø70 - 60X60 - 70X70

alluminio

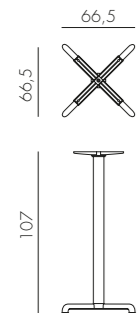

5,5 kg  
n. pz. 1

■ trattamento speciale per ambienti ad alto tasso salino - special treatment for high salinity environments - traitement spécial pour les environnements a haute salinité - Sonderbehandlung für Ambiente mit hohem Salzgehalt - tratamiento especial para ambientes con alta salinidad - tratamiento especial para ambientes con alto teor de sal - yüksek tuza maruz kalan alanlar için özel bakım - Специальная обработка для среды с высоким содержанием соли

Qualora il prodotto venga posizionato in ambienti altamente salini raccomandiamo di scegliere una base con trattamento speciale. If the product is placed in highly salty environments, we recommend choosing a base with a special treatment. Si le produit est placé dans des environnements a haute salinite, nous recommandons de choisir une base avec un traitement spécial. Wenn das Produkt in der Umgebung mit hohem Salzgehalt platziert ist, empfehlen wir, eine Basis mit Sonderbehandlung zu wählen. Si el producto se coloca en ambientes con alta salinidad, recomendamos elegir una base con un tratamiento especial. Se o produto for exposto em ambientes com alto teor de salinidade, recomendamos a escolha de uma base com tratamento especial. Ürünün, salinitesi yüksek olan ortamlarda kullanılması durumunda, özel muamele görmüş versiyonun seçilmesi tavsiye olunur. Если изделие будет использоваться в среде с высоким содержанием соли, рекомендуется выбрать основание со специальной обработкой.

## BASE FLUTE

PIANI Ø60 - Ø70

alluminio

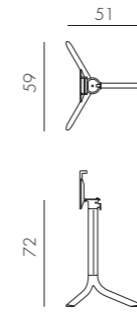

4,9 kg  
n. pz. 1

## BASE BREAK

PIANI Ø60 - Ø70

alluminio

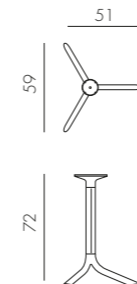









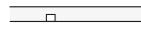





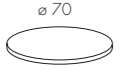

4,3 kg  
n. pz. 1

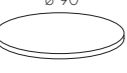
■ trattamento speciale per ambienti ad alto tasso salino - special treatment for high salinity environments - traitement spécial pour les environnements a haute salinité - Sonderbehandlung für Ambiente mit hohem Salzgehalt - tratamiento especial para ambientes con alta salinidad - tratamiento especial para ambientes con alto teor de sal - yüksek tuza maruz kalan alanlar için özel bakım - Специальная обработка для среды с высоким содержанием соли

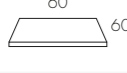

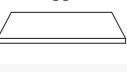
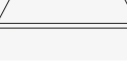
Qualora il prodotto venga posizionato in ambienti altamente salini raccomandiamo di scegliere una base con trattamento speciale. If the product is placed in highly salty environments, we recommend choosing a base with a special treatment. Si le produit est placé dans des environnements a haute salinite, nous recommandons de choisir une base avec un traitement spécial. Wenn das Produkt in der Umgebung mit hohem Salzgehalt platziert ist, empfehlen wir, eine Basis mit Sonderbehandlung zu wählen. Si el producto se coloca en ambientes con alta salinidad, recomendamos elegir una base con un tratamiento especial. Se o produto for exposto em ambientes com alto teor de salinidade, recomendamos a escolha de uma base com tratamento especial. Ürünün, salinitesi yüksek olan ortamlarda kullanılması durumunda, özel muamele görmüş versiyonun seçilmesi tavsiye olunur. Если изделие будет использоваться в среде с высоким содержанием соли, рекомендуется выбрать основание со специальной обработкой.

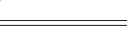
## PIANI LAMINATO

			GRIGIO	BIANCO	CAFFÈ *	ANTRACITE *	CEMENTO	TORTORA
		1 cm <b>new</b>						
piano Ø60		4 kg n. pz. 1	30716.10.300	30716.10.301	30716.10.302	30716.10.303	30716.10.305	30716.10.310
piano Ø70		5,5 kg n. pz. 1	30717.10.300	30717.10.301	30717.10.302	30717.10.303	30717.10.305	30717.10.310
piano Ø80		7 kg n. pz. 1	30718.10.300	30718.10.301	30718.10.302	30718.10.303	30718.10.305	30718.10.310
piano Ø90 ●		9 kg n. pz. 1	30719.10.300	30719.10.301	30719.10.302	30719.10.303	30719.10.305	30719.10.310
piano Ø100 ●			(Solo su richiesta - Only on request - Uniquement sur demande - Nur auf Anfrage - Sólo bajo pedido - Apenas sob encomenda - Sadece istek üzere - Только по запросу)					
piano 60x60		5 kg n. pz. 1	30706.10.300	30706.10.301	30706.10.302	30706.10.303	30706.10.305	30706.10.310
piano 70x70		7 kg n. pz. 1	30707.10.300	30707.10.301	30707.10.302	30707.10.303	30707.10.305	30707.10.310
piano 80x80		9,5 kg n. pz. 1	30708.10.300	30708.10.301	30708.10.302	30708.10.303	30708.10.305	30708.10.310
piano 90x90 ●		11,5 kg n. pz. 1	30709.10.300	30709.10.301	30709.10.302	30709.10.303	30709.10.305	30709.10.310
piano 100x100 ●			(Solo su richiesta - Only on request - Uniquement sur demande - Nur auf Anfrage - Sólo bajo pedido - Apenas sob encomenda - Sadece istek üzere - Только по запросу)					
piano 110x70		11 kg n. pz. 2	30721.10.300	30721.10.301	/	(Solo su richiesta - Only on request - Uniquement sur demande - Nur auf Anfrage - Sólo bajo pedido - Apenas sob encomenda - Sadece istek üzere - Только по запросу)		
piano 120x80		14 kg n. pz. 2	30720.10.300	30720.10.301	/	(Solo su richiesta - Only on request - Uniquement sur demande - Nur auf Anfrage - Sólo bajo pedido - Apenas sob encomenda - Sadece istek üzere - Только по запросу)		

● Solo per Base Frasca Maxi Fix - Only for Base Frasca Maxi Fix - Seulement pour Base Frasca Maxi Fix - Nur für Base Frasca Maxi Fix - Sólo para Base Frasca Maxi Fix - Apenas para Base Frasca Maxi Fix - Sadece Base Frasca Maxi Fix için - Только для Base Frasca Maxi Fix

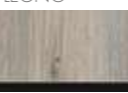
\* Posizionare in zone d'ombra - Position in shaded areas - Placer dans des zones ombragées - In schattigen Bereichen aufstellen - Colocar en zonas de sombra - Posicionar em zonas de sombra - Gölğeli alanlara yerleştiriniz - Размещать в тени

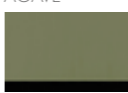
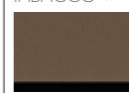
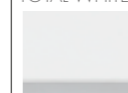
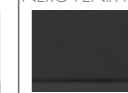
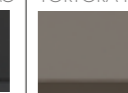
			new			new			
			LEGNO	CORTEN *	AGAVE	TABACCO *	TOTAL WHITE	NERO FENIX NTM®*	TORTORA FENIX
									
			30716.10.311	30716.10.312	30716.10.316	30716.10.317	/	/	/
			30717.10.311	30717.10.312	30717.10.316	30717.10.317	/	/	/
			30718.10.311	30718.10.312	30718.10.316	30718.10.317	/	/	/
			30719.10.311	30719.10.312	30719.10.316	30719.10.317	/	/	/
			(Solo su richiesta - Only on request - Uniquement sur demande - Nur auf Anfrage - Sólo bajo pedido - Apenas sob encomenda - Sadece istek üzere - Только по запросу)						
			30706.10.311	30706.10.312	30706.10.316	30706.10.317	30706.10.314	30706.10.313	30706.10.318
			30707.10.311	30707.10.312	30707.10.316	30707.10.317	30707.10.314	30707.10.313	30707.10.318
			30708.10.311	30708.10.312	30708.10.316	30708.10.317	30708.10.314	30708.10.313	30708.10.318
			30709.10.311	30709.10.312	30709.10.316	30709.10.317	30709.10.314	30709.10.313	30709.10.318
			(Solo su richiesta - Only on request - Uniquement sur demande - Nur auf Anfrage - Sólo bajo pedido - Apenas sob encomenda - Sadece istek üzere - Только по запросу)						
			/	/	/	/	/	/	/
			/	/	/	/	/	/	/

● Solo per Base Frasca Maxi Fix - Only for Base Frasca Maxi Fix - Seulement pour Base Frasca Maxi Fix - Nur für Base Frasca Maxi Fix - Sólo para Base Frasca Maxi Fix - Apenas para Base Frasca Maxi Fix - Sadece Base Frasca Maxi Fix için - Только для Base Frasca Maxi Fix

\* Posizionare in zone d'ombra - Position in shaded areas - Placer dans des zones ombragées - In schattigen Bereichen aufstellen - Colocar en zonas de sombra - Posicionar em zonas de sombra - Gölğeli alanlara yerleştiriniz - Размещать в тени



## SIPARIO 3

polipropilene fiberglass rigenerato

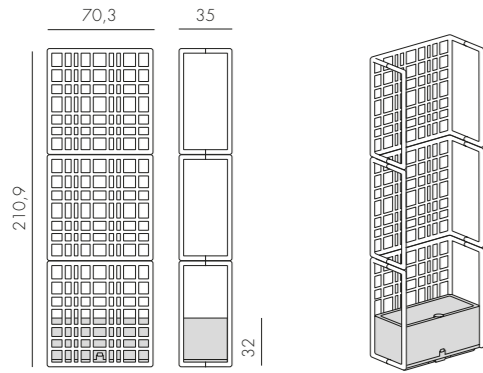

TERRA  
40395.44.000

19,1 kg  
n. pz. 1

## SIPARIO 2



polipropilene fiberglass rigenerato

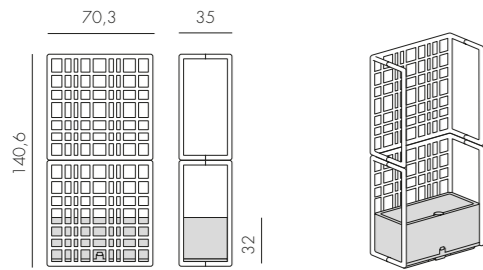

TERRA  
40394.44.000

14,6 kg  
n. pz. 1

## SIPARIO MODULO

polipropilene fiberglass rigenerato

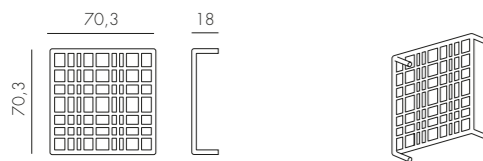

TERRA  
40381.44.000

3,3 kg  
n. pz. 1

Il polipropilene fiberglass rigenerato può subire delle variazioni di colore dovute all'utilizzo di materiale riciclato - Regenerated fiberglass polypropylene may undergo variations in color due to the use of recycled material - Polypropylène fiberglass régénérée peut subir variations de couleur en raison de l'utilisation de matériaux recyclés - Regeneriertem fiberglass-Polypropylen kann aufgrund der Verwendung von recyceltem Material Farbabweichungen unterliegen - El polipropileno fiberglass regenerado puede sufrir variaciones de color debido al uso de material reciclado - O polipropileno fiberglass regenerado pode sofrer variações de cor devido ao uso de material reciclado - Rejenere edilmiş polipropilen fiberglass, geri dönüşüm malzemesi kullanımı nedeniyle renk değişikliklerine maruz kalabilir - Цвет регенерированного полипропиленового стекловолокна может претерпевать изменения вследствие использования переработанного материала.



Life Cycle Assessment

For more information visit [www.nardioutdoor.com/sustainability](http://www.nardioutdoor.com/sustainability)

## SIPARIO VASO

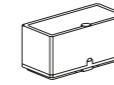
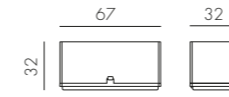

TERRA  
40382.44.000

6,4 kg  
n. pz. 1

## SIPARIO CHIUSURA

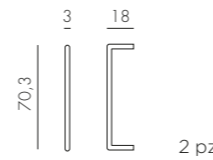

TERRA  
40383.44.000

1 kg  
n. pz. 1

## SIPARIO KIT CLIPS



4 pz



6 pz



TERRA  
40392.44.000

0,4 kg  
n. pz. 1

Il polipropilene fiberglass rigenerato può subire delle variazioni di colore dovute all'utilizzo di materiale riciclato - Regenerated fiberglass polypropylene may undergo variations in color due to the use of recycled material - Polypropylène fiberglass régénérée peut subir variations de couleur en raison de l'utilisation de matériaux recyclés - Regeneriertem fiberglass-Polypropylen kann aufgrund der Verwendung von recyceltem Material Farbabweichungen unterliegen - El polipropileno fiberglass regenerado puede sufrir variaciones de color debido al uso de material reciclado - O polipropileno fiberglass regenerado pode sofrer variações de cor devido ao uso de material reciclado - Rejenere edilmiş polipropilen fiberglass, geri dönüşüm malzemesi kullanımı nedeniyle renk değişikliklerine maruz kalabilir - Цвет регенерированного полипропиленового стекловолокна может претерпевать изменения вследствие использования переработанного материала.

accessori  
*accessories*

## CUSCINO DOGA RELAX **new**

tessuto

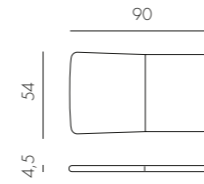

0,7 kg  
n. pz. 4



lino  
36256.00.152

## CUSCINO DOGA ARMCHAIR **new**

tessuto

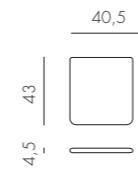

0,3 kg  
n. pz. 4



lino  
36254.00.152

## CUSCINO DOGA BISTROT **new**

tessuto

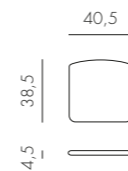

0,25 kg  
n. pz. 4



lino  
36255.00.152

## CUSCINO TRILL

tessuto

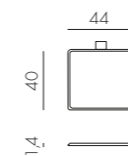

0,2 kg  
n. pz. 4

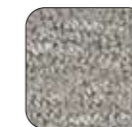

cenere  
36253.00.132

Solo per sedia Trill Bistrot - Only for Trill Bistrot chair  
- Seulement pour la chaise Trill Bistrot - Nur für Trill  
Bistrot Stuhl - Sólo para silla Trill Bistrot - Apenas  
para cadeira Trill Bistrot - Sadece Trill Bistrot san-  
dalyesi için - Только для кресла Trill Bistrot.

## CUSCINO NET BENCH

tessuto

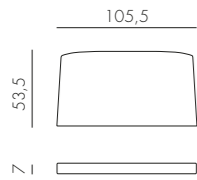

1,5 kg  
n. pz. 4

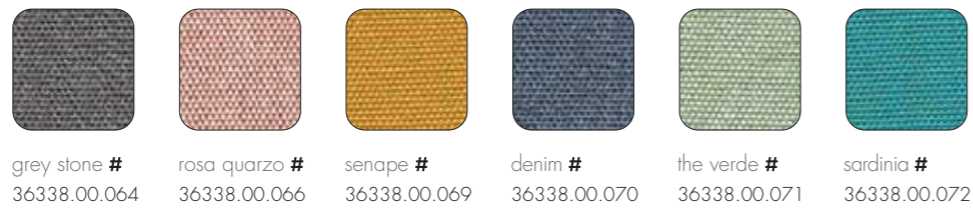

## CUSCINO NET RELAX

tessuto

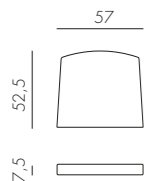

0,8 kg  
n. pz. 4

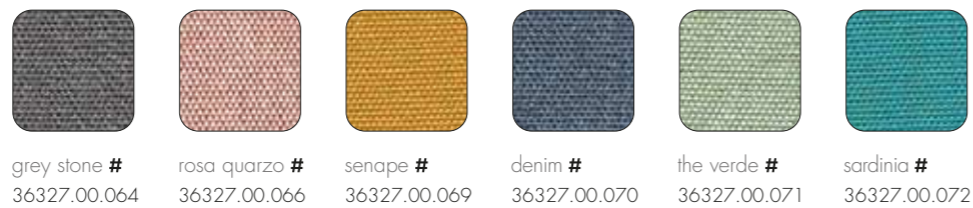

# Variazioni di colore sono da ritenersi standard e naturali nei tessuti acrilici tinto filo. Posizionare in zone d'ombra - Colour variations are to be considered standard and natural in yarn-dyed acrylic fabrics. Position in shaded areas - Les variations de couleur des tissus acryliques au fil teint sont standard et naturelles. Placer dans des zones ombragées - Farbveränderungen sind als Standard und in im Garn gefärbten Acrylgeweben als natürlich zu betrachten. In schattigen Bereichen aufstellen - Las variaciones de color son normales y naturales en las telas acrílicas teñidas en hilo. Colocar en zonas de sombra - As variações de cor são consideradas standard e naturais nos tecidos acrílico tingidos com fio. Posicionar em zonas de sombra - Boyalı akrilik iplik kumaşlarda renk değişiklikleri standart ve doğal kabul edilir. Gölge alanlara yerleştiriniz - Изменения цвета следует считать нормой, они являются естественными в случае акриловых тканей с окрашенными волокнами. Размещать в тени

\* Trattamento laminato su richiesta con quantità minima - Laminated finish available on request with a minimum quantity - Traitement laminé sur demande avec une quantité minimum - Lamierte Ausrüstung auf Anfrage mit einer Mindestmenge - Tratamiento laminado bajo pedido con una cantidad mínima - Tratamento laminado sob encomenda com quantidade mínima - Talep üzerine minimum miktarda lamine işlem - Ламинированная обработка по запросу с минимальным количеством

## CUSCINO SHELL (NET RELAX)

tessuto

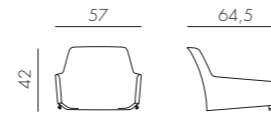

2,2 kg  
n. pz. 2



Utilizzabile solo con cuscino Net Relax - Can only be used with Net Relax cushion - À utiliser uniquement avec le coussin Net Relax - Kann nur mit Net Relax Kissen verwendet werden - Se puede utilizar sólo con el cojín Net Relax - Só pode ser usada em conjunto com almofada de assento Net Relax - Sadece Net Relax minderiyle kullanılmalı - Можно использовать только с подушкой Net Relax.

## CUSCINO NET

tessuto

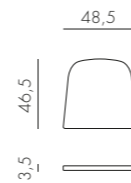

0,3 kg  
n. pz. 4

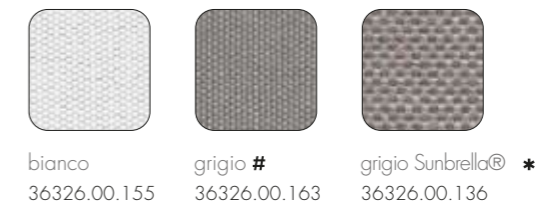

## CUSCINO BIT new

tessuto

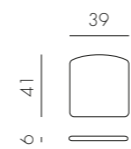

0,3 kg  
n. pz. 4



grigio #  
36328.00.163

# Variazioni di colore sono da ritenersi standard e naturali nei tessuti acrilici tinto filo. Posizionare in zone d'ombra - Colour variations are to be considered standard and natural in yarn-dyed acrylic fabrics. Position in shaded areas - Les variations de couleur des tissus acryliques au fil teint sont standard et naturelles. Placer dans des zones ombragées - Farbveränderungen sind als Standard und in im Garn gefärbten Acrylgeweben als natürlich zu betrachten. In schattigen Bereichen aufstellen - Las variaciones de color son normales y naturales en las telas acrílicas teñidas en hilo. Colocar en zonas de sombra - As variações de cor são consideradas standard e naturais nos tecidos acrílico tingidos com fio. Posicionar em zonas de sombra - Boyalı akrilik iplik kumaşlarda renk değişiklikleri standart ve doğal kabul edilir. Gölge alanlara yerleştiriniz - Изменения цвета следует считать нормой, они являются естественными в случае акриловых тканей с окрашенными волокнами. Размещать в тени

\* Trattamento laminato su richiesta con quantità minima - Laminated finish available on request with a minimum quantity - Traitement laminé sur demande avec une quantité minimum - Lamierte Ausrüstung auf Anfrage mit einer Mindestmenge - Tratamiento laminado bajo pedido con una cantidad mínima - Tratamento laminado sob encomenda com quantidade mínima - Talep üzerine minimum miktarda lamine işlem - Ламинированная обработка по запросу с минимальным количеством

## CUSCINO PASSEPARTOUT

tessuto

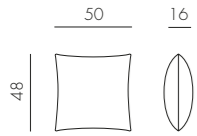

0,7 kg  
n. pz. 4

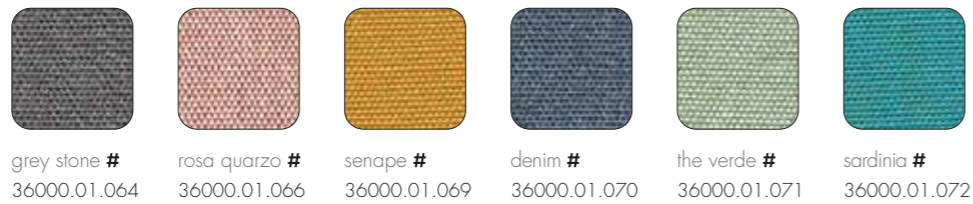

## CUSCINO RETTANGOLARE

tessuto

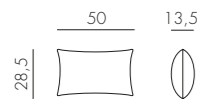

0,55 kg  
n. pz. 4

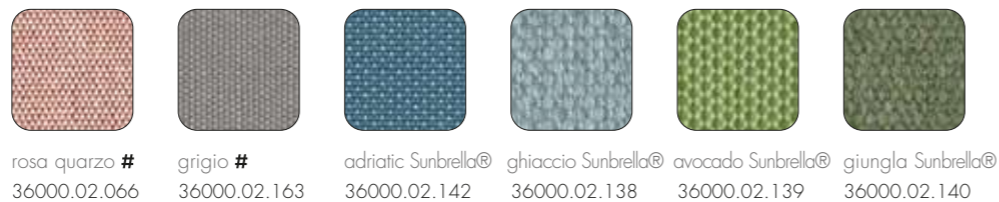

## CUSCINO ACQUAMARINA

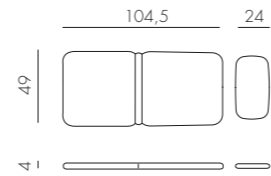

0,9 kg  
n. pz. 4



## CUSCINO DARSENA

tessuto

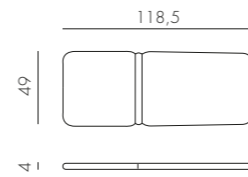

0,8 kg  
n. pz. 4



## CUSCINO EDEN

tessuto

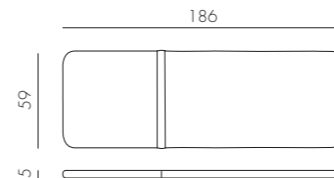

1,8 kg  
n. pz. 4



# Variazioni di colore sono da ritenersi standard e naturali nei tessuti acrilici tinto filo. Posizionare in zone d'ombra - Colour variations are to be considered standard and natural in yarn-dyed acrylic fabrics. Position in shaded areas - Les variations de couleur des tissus acryliques au fil teint sont standard et naturelles. Placer dans des zones ombragées - Farbveränderungen sind als Standard und in im Garn gefärbten Acrylgeweben als natürlich zu betrachten. In schattigen Bereichen aufstellen - Las variaciones de color son normales y naturales en las telas acrílicas teñidas en hilo. Colocar en zonas de sombra - As variações de cor são consideradas standard e naturais nos tecidos acrílico tingidos com fio. Posicionar em zonas de sombra - Boyalı akrilik iplik kumaşlarda renk değişiklikleri standart ve doğal kabul edilir. Gölge alanlara yerleştiriniz - Изменения цвета следует считать нормой, они являются естественными в случае акриловых тканей с окрашенными волокнами. Размещать в тени

# Variazioni di colore sono da ritenersi standard e naturali nei tessuti acrilici tinto filo. Posizionare in zone d'ombra - Colour variations are to be considered standard and natural in yarn-dyed acrylic fabrics. Position in shaded areas - Les variations de couleur des tissus acryliques au fil teint sont standard et naturelles. Placer dans des zones ombragées - Farbveränderungen sind als Standard und in im Garn gefärbten Acrylgeweben als natürlich zu betrachten. In schattigen Bereichen aufstellen - Las variaciones de color son normales y naturales en las telas acrílicas teñidas en hilo. Colocar en zonas de sombra - As variações de cor são consideradas standard e naturais nos tecidos acrílico tingidos com fio. Posicionar em zonas de sombra - Boyalı akrilik iplik kumaşlarda renk değişiklikleri standart ve doğal kabul edilir. Gölge alanlara yerleştiriniz - Изменения цвета следует считать нормой, они являются естественными в случае акриловых тканей с окрашенными волокнами. Размещать в тени

COVER SMALL **new** (4/6 SEDUTE / DIVANO 1 ELEMENTO)

tessuto

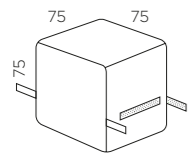

smoke  
37000.01.204

COVER MEDIUM **new** (2/4 LETTINI)

tessuto

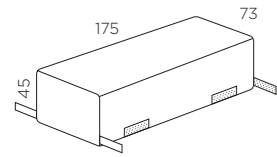

smoke  
37000.02.204

COVER LARGE **new** (DIVANO 2 ELEMENTI / TAVOLO 140)

tessuto

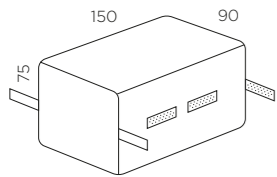

smoke  
37000.03.204

COVER EXTRALARGE **new** (DIVANO 3 ELEMENTI / TAVOLO 210)

tessuto

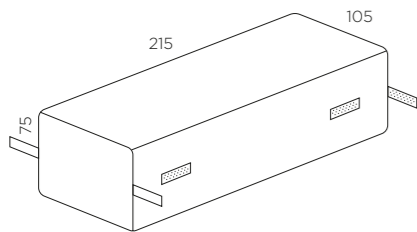

smoke  
37000.04.204

materiali  
*materials*

## polipropilene

Polipropilene trattato anti-UV e colorato in massa. Riciclabile al 100%.  
Polypropylene with UV additives and is uniformly colored. 100% Recyclable resin.  
Polypropylène traité anti-UV et coloré dans la masse. Résine recyclable 100%.  
UV-beständigem Polypropylen, voll durchgefärbt. 100% Recyclebarer Kunststoff.  
Polipropileno tratado anti-UV y teñido en masa. Resina reciclable 100%.  
Polipropileno com tratamento anti-UV colorido na totalidade. Resina reciclável 100%.  
Işığa dayanıklı ve boyalı olarak granül çekilmiş %100 geri dönüşümlü polipropilen kompozit hammaddede.  
Полипропилен с обработкой анти-УФ, окрашенное в массе. На 100% пригодно для вторичной переработки.



BIANCO .00



GRIGIO .03



ANTRACITE .02



TORTORA .10



TABACCO .53



CAFFE' .05



CELESTE .39



OTTANIO .49



SALICE .04



MENTA .15



AGAVE .16



PERA .18



CAPPUCCINO .14



SENAPE .56

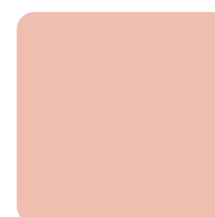

ROSA BOUQUET .08



MARSALA .21



CORALLO .75



ROSSO .07

## polipropilene fiberglass

Polipropilene fiberglass trattato anti-UV e colorato in massa. Resina riciclabile al 100%.  
Uniformly colored fiberglass polypropylene resins with UV additives. 100% Recyclable resin.  
Polypropylène fiberglass traité anti-UV et coloré dans la masse. Résine recyclable 100%.  
UV-beständigem fiberglass Polypropylen, voll durchgefärbt. 100% Recyclebarer Kunststoff.  
Polipropileno fiberglass tratado anti-UV y teñido en masa. Resina reciclable 100%.  
Polipropileno fiberglass com tratamento anti-UV colorido na totalidade. Resina reciclável 100%.  
Işığa dayanıklı ve boyalı olarak granül çekilmiş %100 geri dönüşümlü cam elyaf katkılı polipropilen kompozit hammaddede.  
Полипропилен фиброволокно с обработкой анти-УФ, окрашенное в массе. На 100% пригодно для вторичной переработки.



BIANCO .00



GRIGIO .03



ANTRACITE .02



TORTORA .10



TABACCO .53



CAFFE' .05



CELESTE .39



OTTANIO .49



SALICE .04



MENTA .15



AGAVE .16



PERA .18



CAPPUCCINO .14



SENAPE .56

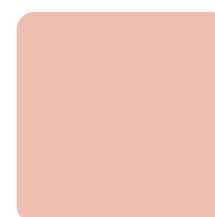

ROSA BOUQUET .08



MARSALA .21



CORALLO .75



ROSSO .07

## polipropilene fiberglass rigenerato

Polipropilene fiberglass rigenerato trattato anti-UV e colorato in massa. Resina riciclabile al 100%. Il polipropilene fiberglass rigenerato può subire delle variazioni di colore dovute all'utilizzo di materiale riciclato.  
Regenerated uniformly colored fiberglass polypropylene resins with UV additives. 100% Recyclable resin. Regenerated fiberglass polypropylene may undergo variations in color due to the use of recycled material.  
Polypropylène fiberglass régénérée traité anti-UV et coloré dans la masse. Résine recyclable 100%. Polypropylène fiberglass régénérée peut subir variations de couleur en raison de l'utilisation de matériaux recyclés.  
Regeneriertem UV-beständigem fiberglass-Polypropylen, voll durchgefärbt. 100% Recyclebarer Kunststoff. Regeneriertem fiberglass-Polypropylen kann aufgrund der Verwendung von recyceltem Material Farbabweichungen unterliegen.



TERRA .44

Polipropileno fiberglass regenerado tratado anti-UV y teñido en masa. Resina reciclable 100%. El polipropileno fiberglass regenerado puede sufrir variaciones de color debido al uso de material reciclado.  
Polipropileno fiberglass regenerado com tratamento anti-UV colorido na totalidade. Resina reciclável 100%. O polipropileno fiberglass regenerado pode sofrer variações de cor devido ao uso de material reciclado.  
UV katılı maddeleriyle fiberglass polipropilen reçine ile renklendirilip düzgün bir şekilde tekrar oluşturulmuştur. Rejenere edilmiş polipropilen fiberglass, geri dönüşüm malzemesi kullanımı nedeniyle renk değişikliklerine maruz kalabilir.  
Переработанный, крашеный, полипропилен fiberglass обработанный против проникновения ультрафиолетовых лучей. На 100% пригодно для вторичной переработки. Цвет регенерированного полипропиленового стекловолокна может претерпеть изменения вследствие использования переработанного материала.

## tessuto acrilico #

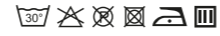

Fibra acrilica 100% tinto filo. Trattamento antimacchia, antimuffa. Solidità alla luce 5/8. Lavabile a 30°.  
 100% yarn dyed acrylic. Dirt repellent and anti-mould treatment. 5/8 light fastness. Washable at 30°.  
 100% fibre acrylique teintée en fils. Traitement anti-taches et anti-moisissure. Résistance à la lumière 5/8. Lavable à 30°.  
 100% garngefärbtes Polyacryl Gewebe. Gegen Flecken und Schimmel Ausrüstung. Lichtechtheit 5/8. Waschbar bei 30°.

100% hilo teñido acrílico. Protección antimanchas, antimoho. Solidez a la luz 5/8. Lavable a 30°.  
 100% fibra acrílica tingida com fio. Tratamento antimancha e antimoho. Resistência à luz 5/8. Lavável a 30°.  
 %100 akrilik elyaf boyalı iplik. Leke itici, küf önleyici ile muamele edilmiş. Işık haslığı 5/8. 30°de yıkanabilir.  
 Акриловое волокно 100% окрашенное в пряже. Пятноустойчивая и противогрибковая обработка. Светостойкость 5/8. Стирать при 30°.

# Variazioni di colore sono da ritenersi standard e naturali nei tessuti acrilici tinto filo. Posizionare in zone d'ombra - Colour variations are to be considered standard and natural in yarn-dyed acrylic fabrics. Position in shaded areas - Les variations de couleur des tissus acryliques au fil teint sont standard et naturelles. Placer dans des zones ombragées - Farbveränderungen sind als Standard und in im Garn gefärbten Acrylgeweben als natürlich zu betrachten. In schattigen Bereichen aufstellen - Las variaciones de color

son normales y naturales en las telas acrílicas teñidas en hilo. Colocar en zonas de sombra - As variações de cor são consideradas standard e naturais nos tecidos acrílico tingidos com fio. Posicionar em zonas de sombra - Boyalı akrilik iplik kumaşlarda renk değişiklikleri standart ve doğal kabul edilir. Gölge alanlara yerleştiriniz - Изменения цвета следует считать нормой, они являются естественными в случае акриловых тканей с окрашенными волокнами. Размещать в тени.

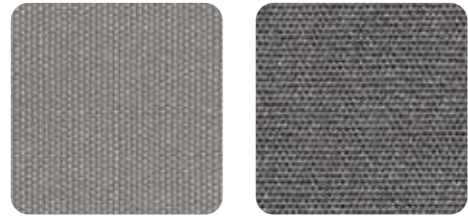

grigio .163  
240 gr/m<sup>2</sup>

grey stone .064  
240 gr/m<sup>2</sup>



artic .161  
240 gr/m<sup>2</sup>

sardinia .072  
240 gr/m<sup>2</sup>

denim .070  
240 gr/m<sup>2</sup>

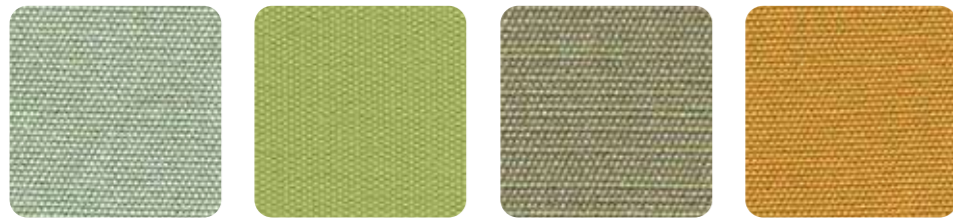

the verde .071  
240 gr/m<sup>2</sup>

lime .061  
240 gr/m<sup>2</sup>

felce .162  
240 gr/m<sup>2</sup>

senape .069  
240 gr/m<sup>2</sup>

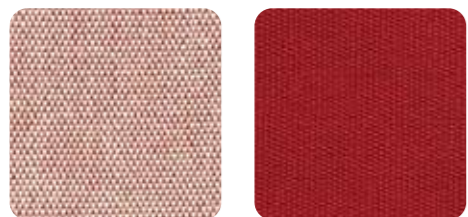

rosa quarzo .066  
240 gr/m<sup>2</sup>

cherry .065  
240 gr/m<sup>2</sup>

## tessuto acrilico Sunbrella®



100% fibra acrilica Sunbrella® tinto in massa. Trattamento idrorepellente, antimacchia, antimuffa. Solidità alla luce 8/8. Lavabile a 40°.  
 100% Sunbrella® acrylic fiber mass dyed. Water repellent treatment, dirt repellent and anti-mould treatment. 8/8 light fastness. Washable at 40°.  
 100% fibre acrylique Sunbrella® teintée en masse. Traitement imperméable, anti-taches et anti-moisissure. Résistance à la lumière 8/8. Lavable à 40°.  
 100% fasergefärbtes Sunbrella® Polyacryl. Wasserabweisend Ausrüstung, gegen Flecken und Schimmel ausgerüstet. Lichtechtheit 8/8. Waschbar bei 40°.

100% fibra acrílica Sunbrella® tintada en masa. Tratamiento por la repelencia al agua, protección antimanchas, antimoho. Solidez a la luz 8/8. Lavable a 40°.  
 100% fibra acrílica Sunbrella® tingida em massa. Tratamento hidrorrepelente, antimancha e antimoho. Resistência à luz 8/8. Lavável a 40°.  
 %100 akrilik elyaf Sunbrella® çözelti halindeyken boyanmış. Su itici, leke itici, küf önleyici ile muamele edilmiş. Işık haslığı 8/8. 40°de yıkanabilir.  
 100% акриловое волокно Sunbrella®, окрашенное в массе. Водоотталкивающая, пятноустойчивая и противогрибковая обработка. Светостойкость 8/8. Стирать при 40°.

★ 50% fibra acrilica Sunbrella® riciclata tinto in massa, 47% fibra acrilica Sunbrella® tinto in massa, 3% poliéster.  
 50% blended Sunbrella® acrylic fiber mass dyed, 47% Sunbrella® acrylic fiber mass dyed, 3% polyester.  
 50% fibre acrylique Sunbrella® recyclée teintée en masse, 47% fibre acrylique Sunbrella® teintée en masse, 3% de polyester.  
 50% fasergefärbtes, recyceltes Sunbrella® Polyacryl, 47% fasergefärbtes Sunbrella® Polyacryl, 3% Polyester.

50% fibra acrílica Sunbrella® reciclada tintada en masa, 47% fibra acrílica Sunbrella® tintada en masa, 3% poliéster.  
 50% fibra acrílica Sunbrella® reciclada tingida em massa, 47% fibra acrílica Sunbrella® tingida em massa, 3% de poliéster.  
 %50 geri dönüştürülmüş akrilik elyaf Sunbrella® çözelti halindeyken boyanmış, %47 akrilik elyaf Sunbrella® çözelti halindeyken boyanmış, %3 polyester.  
 50% переработанное акриловое волокно Sunbrella® окрашенное в массе, 47% акриловое волокно Sunbrella®, окрашенное в массе, 3% полиэстер.

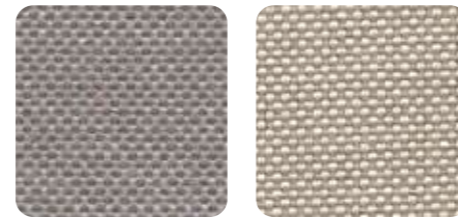

grigio Sunbrella® .136  
275 gr/m<sup>2</sup>

canvas Sunbrella® .141  
275 gr/m<sup>2</sup>

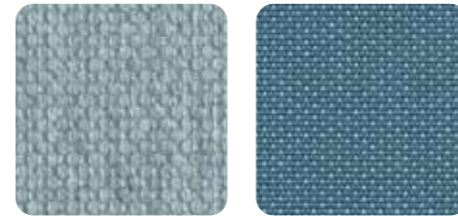

ghiaccio Sunbrella® .138  
275 gr/m<sup>2</sup>

adriatic Sunbrella® .142  
260 gr/m<sup>2</sup>

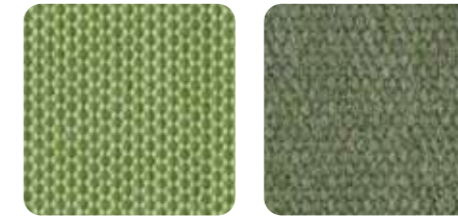

avocado Sunbrella® .139  
260 gr/m<sup>2</sup>

giungla Sunbrella® .140 ★  
340 gr/m<sup>2</sup>

## Sunbrella® EXTRA



Tessuti disponibili su ordinazione per minimi quantitativi d'ordine solo per il prodotto KOMODO.  
Fabrics available to order for minimum order quantities for the KOMODO product only.  
Tissus disponibles sur commande de quantités minimales pour le produit KOMODO uniquement.  
Gewebe auf Bestellung für Mindestbestellmengen nur für das Produkt KOMODO erhältlich.

Telas disponibles bajo pedido para cantidades mínimas solo para el producto KOMODO.  
Tecidos disponíveis por encomenda para quantidades mínimas de encomenda apenas para o produto KOMODO.  
Sadece KOMODO ürünü için minimum sipariş miktarına göre sipariş verilebilecek kumaşlar.  
ткани на заказ для минимального объема заказа только для изделия KOMODO.

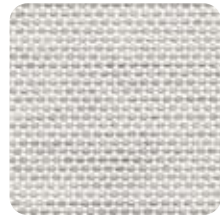

marble  
Sunbrella® .186  
260 gr/m<sup>2</sup>

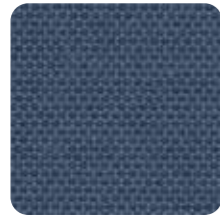

blue storm  
Sunbrella® .185  
260 gr/m<sup>2</sup>

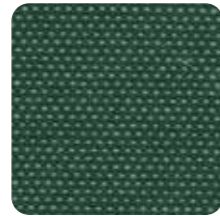

alpine  
Sunbrella® .182  
260 gr/m<sup>2</sup>

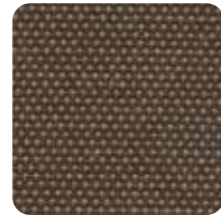

mink brown  
Sunbrella® .183  
260 gr/m<sup>2</sup>

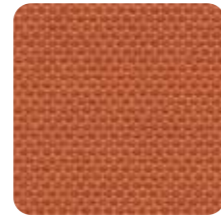

pumpkin  
Sunbrella® .184  
260 gr/m<sup>2</sup>



opera  
Sunbrella® .187  
260 gr/m<sup>2</sup>

## trattamento laminato

(Su richiesta - On request - Sur demande - Auf Anfrage - Bajo pedido - Sob encomenda - İstek üzerine - По запросу)



Il tessuto è accoppiato internamente con un film in poliuretano che lo rende impermeabile. La parte accoppiata in poliuretano non deve essere esposta al sole. Applicabile su richiesta con quantità minima su tessuti acrilici Sunbrella®.  
The fabric is bonded with a polyurethane film that makes it waterproof. The polyurethane laminated surface should not be exposed to direct sunlight. Applicable on Sunbrella® acrylic fabrics on request with a minimum quantity.  
Le tissu est doublé en interne avec un film de polyuréthane qui le rend imperméable. La partie en polyuréthane ne doit pas être exposée au soleil. Applicable sur demande avec une quantité minimale sur les tissus acryliques Sunbrella®.  
Das Gewebe ist innen mit einer Polyurethanfolie verbunden, die es wasserdicht macht. Das mit Polyurethan verbundene Teil darf nicht der Sonne ausgesetzt werden. Auf Anfrage mit Mindestmenge auf Sunbrella® Polyacryl Gewebe anwendbar.

El tejido está acoplado internamente con una película de poliuretano que lo hace impermeable. La parte acoplada de poliuretano no debe exponerse al sol. Aplicable bajo pedido con una cantidad mínima en tejidos acrílicos Sunbrella®.  
O tecido é dublado com filme interno de poliuretano que o torna impermeável. O lado que possui o filme de poliuretano não pode ser exposta ao sol. Aplicável sob encomenda, com quantidade mínima, em tecidos acrílicos Sunbrella®.  
Kumaş, su geçirmez hale getiren bir poliüretan film ile dahili olarak birleştirilmiştir. Birleştirilmiş poliüretan bölümler güneşe maruz bırakılmamalıdır. Sunbrella® akrilik kumaşlar üzerine minimum miktarda istek üzerine uygulanabilir.  
Ткань внутренне соединена с полиуретановой пленкой, которая делает ее водонепроницаемой. та часть ,где имеется добавка полиуритана не выставлять на солнце. Применяется по запросу с минимальным количеством на акриловых тканях Sunbrella®.

## tessuto acrilico tinto massa



100% fibra acrilica tinto in massa. Trattamento idrorepellente, antimacchia, antimuffa. Solidità alla luce 7/8. Lavabile a 30°.  
100% acrylic fiber mass dyed. Water repellent treatment, dirt repellent and anti-mould treatment. 7/8 light fastness. Washable at 30°.  
100% fibre acrylique teintée en masse. Traitement imperméable, anti-taches et anti-moisissure. Résistance à la lumière 7/8. Lavable à 30°.  
100% fasergefärbtes Polyacryl. Wasserabweisend Ausrüstung, gegen Flecken und Schimmel ausgerüstet. Lichtechtheit 7/8. Waschbar bei 30°.

100% fibra acrilica tintada en masa. Tratamiento hidropelente, protección antimanchas, antimoho. Solidez a la luz 7/8. Lavable a 30°.  
100% fibra acrilica tingida em massa. Tratamento hidropelente, antimancha e antimoho. Resistência à luz 7/8. Lavável a 30°.  
%100 akrilik elyaf çözeltili halindeyken boyanmış. Su itici, leke itici, küf önleyici ile muamele edilmiş. Işık haslığı 7/8. 30°de yıkanabilir.  
100% акриловое волокно окрашенное в массе. Водоотталкивающая, пятноустойчивая и противогрибковая обработка. Светостойкость 7/8. Стирать при 30°.



lino .152  
280 gr/m<sup>2</sup>

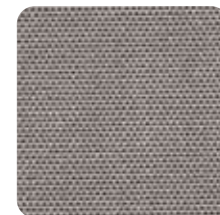

grigio Komodo .172  
240 gr/m<sup>2</sup>

## tessuto acrilico tinto massa per Komodo ombra



100% fibra acrilica tinto in massa. Trattamento idrorepellente, antimacchia, antimuffa. Solidità alla luce 7-8/8. Lavabile a 30°. Il tessuto Velo deve essere impiegato solo come telo-parasole. La maglia larga permette l'aerazione e allo stesso tempo crea una zona d'ombra sottostante ma non trattiene l'acqua.  
100% acrylic fiber mass dyed. Water repellent treatment, dirt repellent and anti-mould treatment. 7-8/8 light fastness. Washable at 30°. Velo fabric should only be used for sunshades. Its wide mesh allows ventilation while creating a shaded area below, but it does not retain water.  
100% fibre acrylique teintée en masse. Traitement imperméable, anti-taches et anti-moisissure. Résistance à la lumière 7-8/8. Lavable à 30°. Le tissu Velo ne doit être utilisé que comme toile de parasol. Les mailles larges permettant de s'aérer tout en créant, en même temps, une zone d'ombre en dessous. Velo n'est pas imperméable.  
100% fasergefärbtes Polyacryl. Wasserabweisend Ausrüstung, gegen Flecken und Schimmel ausgerüstet. Lichtechtheit 7-8/8. Waschbar bei 30°. Das Gewebe Velo darf nur als Sonnenschutz verwendet werden. Die großen Maschen gestatten die Belüftung und gleichzeitig bildet sich darunter ein Schattenbereich, doch es hält Wasser nicht zurück.  
100% fibra acrilica tintada en masa. Tratamiento hidropelente, protección antimanchas, anti-

moho. Solidez a la luz 7-8/8. Lavable a 30°. La tela Velo debe utilizarse únicamente como parasol, la malla ancha permite la ventilación y crea por debajo una zona de sombra, pero no protege del agua.  
100% fibra acrilica tingida em massa. Tratamento hidropelente, antimancha e antimoho. Resistência à luz 7-8/8. Lavável a 30°. O tecido Velo deve ser utilizado apenas como pano guarda-sol, a malha larga permite o arejamento e ao mesmo tempo cria uma zona de sombra subjacente, mas não retém a água.  
%100 akrilik elyaf çözeltili halindeyken boyanmış. Su itici, leke itici, küf önleyici ile muamele edilmiş. Işık haslığı 7-8/8. 30°de yıkanabilir. Velo dokuma sadece güneşlik olarak kullanılmalıdır, geniş gözenekler havalandırma sağlar ve aynı zamanda aşağıda bir gölge alanı oluşturur, fakat su tutma özelliği yoktur.  
100% акриловое волокно, окрашенное в массе. Водоотталкивающая, пятноустойчивая и противогрибковая обработка. Светостойкость 7-8/8. стирать при 30°. Ткань Velo предназначена исключительно для использования в качестве тента для защиты от солнца. Переплетение в виде крупной сетки обеспечивает вентиляцию и в то же время создает затенение под собой, но не задерживает влагу.

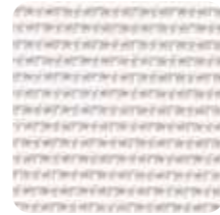

velo white .203  
150 gr/m<sup>2</sup>

## tessuto acrilico stampato



Fibra acrilica 100% stampa digitale. Solidità alla luce 6. Lavabile a 30°.  
100% acrylic fiber with digital print. 6 light fastness. Washable at 30°.  
100% fibre acrylique impression numérique. Résistance à la lumière 6. Lavable à 30°.  
100% Polyacrylfaser mit Digitaldruck. Lichtechtheit 6. Waschbar bei 30°.  
100% fibra acrilica impresión digital. Solidez a la luz 6. Lavable a 30°.

100% fibra acrilica estampa digital. Resistência à luz 6. Lavável a 30°.  
%100 dijital baskı akrilik elyaf. Işık haslığı 6. 30°de yıkanabilir.  
100% акриловое волокно с цифровым рисунком, окрашенное в процессе производства. Светостойкость 6. Стирка при 30°.



tropical .081  
190 gr/m<sup>2</sup>



## TECH



50% vinile e 50% poliestere. Trattamento idrorepellente, antimacchia, antimuffa, ignifugo e antibatterico. Solidità alla luce 6. Lavare a mano in acqua fredda. Alla base dei cuscini seduta komodo TECH panama viene applicata una rete a maglia larga in poliestere per permettere la traspirazione.

50% vinyl and 50% polyester. The treatment makes the coating: water repellent, and resistant to staining, resistant to mold, fire retardant, and antibacterial. 6 light fastness. Hand wash in cold water. At the bottom of the komodo seat cushions, made with TECH panama, the fabric is a polyester wide mesh to allow breathability.

50% vinyle et 50% polyester. Traitement imperméable, anti-taches, anti-moisissures, ignifugé et antibactérien. Résistance à la lumière 6. Laver à la main à l'eau froide. À la base des coussins d'assise komodo TECH panama, un filet de polyester à larges mailles est appliqué pour évacuer la transpiration.

50% Vinyl und 50% Polyester. Wasserabweisend, gegen Flecken und Schimmelbildung ausgerüstet, feuerfest und antibakteriell. Lichtechtheit 6. Handwäsche in kaltem Wasser. Auf der Unterseite der TECH panama Komodo-Sitzkissen ist ein atmungsaktives Polyesternetz mit großer Maschenweite angebracht, um Luftaustausch zu ermöglichen.



TECH panama .131

830 gr/m<sup>2</sup>

## tessuto 100% Olefin



100% Olefin tinta in massa. Trattamento antimacchia, antimuffa. Solidità alla luce 7/8. Lavabile a 40°.

100% Olefin mass dyed. Dirt repellent and anti-mould treatment. 7/8 light fastness. Washable at 40°.

100% Olefin teintée en masse. Traitement anti-taches et anti-moisissure. Résistance à la lumière 7/8. Lavable à 40°.

100% fasergefärbtes Olefin. Gegen Flecken und Schimmel Ausrüstung. Lichtechtheit 7/8. Waschbar bei 40°.



bianco .155

190 gr/m<sup>2</sup>



caffè .165

190 gr/m<sup>2</sup>

50% vinilo y 50% poliéster. Tratamiento para repeler el agua, ignífugo y antibacteriano, protección antimanchas, antimoho. Solidez a la luz 6. Lavar a mano en agua fría. En la base de los cojines de asiento del komodo TECH panama, se aplica una red de poliéster de malla ancha para permitir la transpiración.

50% de vinil e 50% de poliéster. Tratamiento hidorepelente, antimancha e antimoho, resistente ao fogo e antibacteriano. Resistência à luz 6. Lavar à mão em água fria. Na base das almofadas do assento de komodo TECH panama, é aplicada uma tela de poliéster de malha larga para permitir a transpiração.

% 50 vinil ve % 50 polyester. Su Geçirmez Uygulama,kir tutmaz ve küf önleyici uygulama,yan-gın geciktirici ve antibakteriyel uygulama. Işık haslığı 6. Gerektiğinde, el ile soğuk suda yıkanabilir. Hava alması için komodo'nun altındaTECH panama minderle, geniş fileli polyester uygulanmıştır.

50% винил и 50% полиэстер. типы обработки: водоталкивающая,пятноталкивающая,пленсеньоталкивающая,невозгораемая и антибактериальная устойчивость к . Светостойкость 6. Ручная стирка в холодной воде. в основе подушек komodo материал Tech panama добавлена сетка с широкой вязкой из полиэстера, чтобы материал проветривался.

## tessuto 100% Olefin idrorepellente



100% Olefin tinta in massa. Trattamento con resina poliuretano/acrilica, idrorepellente. Solidità alla luce 7/8. Lavabile a 40°.

100% Olefin mass dyed. Treatment with polyurethane/acrylic resin, water-repellent. 7/8 light fastness. Washable at 40°.

100% Olefin teintée en masse. Traitement avec une résine de polyuréthane/acrylique, imperméable. Résistance à la lumière 7/8. Lavable à 40°.

100% fasergefärbtes Olefin. Ausrüstung mit Polyurethan-Harz/Polyacryl, wasserabweisend. Lichtechtheit 7/8. Waschbar bei 40°.



écru .160

220 gr/m<sup>2</sup>



blu .076

220 gr/m<sup>2</sup>

## cuscino Trill termoformato



Tessuto Sunbrella® Terry: 76% fibra acrilica Sunbrella® tinta in massa e 24% poliestere. Trattamento antimacchia, antimuffa. Solidità alla luce 7/8. Senza cuciture. Lavabile a 30°.

Imbottitura: poliuretano espanso rivestito da una membrana TPU waterproof. Densità 40 kg/m<sup>3</sup>. Sunbrella® Terry Fabric: 76% Sunbrella® acrylic fiber mass dyed and 24% polyester. Dirt repellent and anti-mould treatment. 7/8 light fastness. Seamless. Washable at 30°. Padding: polyurethane foam with a TPU waterproof membrane coating. Density 40 kg/m<sup>3</sup>.

Sunbrella® Terry Tissu: 76% fibre acrylique Sunbrella® teintée en masse et 24% polyester. Traitement anti-taches et anti-moisissure. Résistance à la lumière 7/8. Sans couture. Lavable à 30°. Rembourrage: mousse polyuréthane revêtu d'une membrane TPU imperméable. Densité 40 kg/m<sup>3</sup>.

Sunbrella® Terry Gewebe: 76% fasergefärbtes Polyacryl Sunbrella® und 24% Polyester. Gegen Flecken und Schimmel Ausrüstung. Lichtechtheit 7/8. Ohne Nähte. Waschbar bei 30°. Polsterung: Polyurethanschäum mit einer wasserdichten TPU-Membran abgedeckt. Dichte 40 kg/m<sup>3</sup>.



cenere .132

550 gr/m<sup>2</sup>

100% Olefin tintada en masa. Tratamiento con resina de poliuretano/acrilico, repelente al agua. Solidez a la luz 7/8. Lavable a 40°.

100% Olefin tingida em massa. Tratamento com resina de poliuretano/acrilico, hidorepelente. Resistência à luz 7/8. Lavável a 40°.

100% Olefin çözelti halindeyken boyanmış. Poliüretan reçene/akrilik ile muamele edilmiş, su itici. Işık haslığı 7/8. 40°de yıkanabilir.

100% Olefin, окрашенный в массе. Обработка полиуретановым/акриловым полимером, водоотталкивающая. Светостойкость 7/8. Стирать при 40°.

## tessuto Cover



56% poliestere e 44% poliuretano. Trattamento idrorepellente, antimacchia, antimuffa e antibatterico. Solidità alla luce 7/8. Lavabile a 95° con detergente neutro.

56% polyester and 44% polyurethane. The treatment makes the coating: water repellent, and resistant to staining, resistant to mold and antibacterial. 7/8 light fastness. Washable at 95° with neutral detergent.

56% polyester et 44% polyuréthane. Traitement imperméable, anti-taches, anti-moisissures et antibactérien. Résistance à la lumière 7/8. Lavable à 95° avec un détergent neutre.

56% Polyester und 44% Polyurethan. VVasserabweisend, gegen Flecken und Schimmelbildung ausgerüstet und antibakteriell. Lichteichtheit 7/8. Waschbar bei 95° mit Neutralwaschmittel.



smoke .204

205 gr/m<sup>2</sup>

## imbottitura

### CUSCINO FOLIO COMFORT

Poliuretano espanso (densità 18 kg/m<sup>3</sup>) rivestito da fibra di poliestere accoppiata al tessuto. Polyurethane foam (density 18 kg/m<sup>3</sup>) with a polyester fiber coating bonded to the fabric. Mousse polyuréthane (densité 18 kg/m<sup>3</sup>) revêtu de fibre de polyester couplé au tissu. Polyurethanschäum (Dichte 18 kg/m<sup>3</sup>) mit Polyesterfasern beschichtet, gekoppelt mit dem Gewebe. Espuma de poliuretano (densidad 18 kg/m<sup>3</sup>) cubierta con fibras de poliéster acoplada con el tejido. Espuma de poliuretano (densidade 18 kg/m<sup>3</sup>) com cobertura fibras de poliéster acoplada ao tecido. Kumaşa birleştirilmiş polyester elyafın kaplanmış genişletilmiş poliüretan (yoğunluk 18 kg/m<sup>3</sup>). Расширенный полиуретан (плотность 18 кг/м<sup>3</sup>), покрытый полиэфирным волокном, соединенным с тканью.

### CUSCINO NET BENCH - CUSCINO NET RELAX - CUSCINO NET - CUSCINO FIT ARIA - CUSCINO ACQUAMARINA - CUSCINO DARSENA

Poliuretano espanso. Densità 28 kg/m<sup>3</sup>. Polyurethane foam. Density 28 kg/m<sup>3</sup>. Mousse polyuréthane. Densité 28 kg/m<sup>3</sup>. Polyurethanschäum. Dichte 28 kg/m<sup>3</sup>. Espuma de poliuretano. Densidad 28 kg/m<sup>3</sup>. Espuma de poliuretano. Densidade 28 kg/m<sup>3</sup>. Poliüretan köpük. Yoğunluk 28 kg/m<sup>3</sup>. Пенополиуретан. Плотность 28 кг/м<sup>3</sup>.

### CUSCINO SEDUTA ARIA

Poliuretano espanso. Densità 25 kg/m<sup>3</sup>. Polyurethane foam. Density 25 kg/m<sup>3</sup>. Mousse polyuréthane. Densité 25 kg/m<sup>3</sup>. Polyurethanschäum. Dichte 25 kg/m<sup>3</sup>. Espuma de poliuretano. Densidad 25 kg/m<sup>3</sup>. Espuma de poliuretano. Densidade 25 kg/m<sup>3</sup>. Poliüretan köpük. Yoğunluk 25 kg/m<sup>3</sup>. Пенополиуретан. Плотность 25 кг/м<sup>3</sup>.

### CUSCINO SHELL NET RELAX

Poliuretano espanso su struttura rigida di polipropilene. Densità 70 kg/m<sup>3</sup>. Polyurethane foam over solid polypropylene frame. Density 70 kg/m<sup>3</sup>. Mousse polyuréthane sur structure rigide de polypropylène. Densité 70 kg/m<sup>3</sup>. Polyurethanschäum auf steifer Polypropylengestell. Dichte 70 kg/m<sup>3</sup>. Espuma de poliuretano sobre estructura rígida de polipropileno. Densidad 70 kg/m<sup>3</sup>. Espuma de poliuretano sobre estrutura rígida de polipropileno. Densidade 70 kg/m<sup>3</sup>. Sert polipropilen gövde üzerindeki poliüretan köpük minder. Yoğunluk 70 kg/m<sup>3</sup>. Пенополиуретан. на жесткой конструкции из полипропилена. Плотность 70 кг/м<sup>3</sup>.

### CUSCINO DOGA RELAX - CUSCINO DOGA ARMCHAIR - CUSCINO DOGA BISTROT

Poliuretano espanso (densità 18 kg/m<sup>3</sup>) rivestito da fibra di poliestere (densità 100 gr/m<sup>2</sup>). Polyurethane foam (density 18 kg/m<sup>3</sup>) with a polyester fiber coating (density 100 gr/m<sup>2</sup>). Mousse polyuréthane (densité 18 kg/m<sup>3</sup>) revêtu de fibre de polyester (densité 100 gr/m<sup>2</sup>). Polyurethanschäum (Dichte 18 kg/m<sup>3</sup>) mit Polyesterfasern beschichtet (Dichte 100 gr/m<sup>2</sup>). Espuma de poliuretano (densidad 18 kg/m<sup>3</sup>) cubierta con fibras de poliéster (densidad 100 gr/m<sup>2</sup>). Espuma de poliuretano (densidade 18 kg/m<sup>3</sup>) com cobertura fibras de poliéster (densidade 100 gr/m<sup>2</sup>). Polyester elyaf (Yoğunluk 100 gr/m<sup>2</sup>) kaplı köpük poliüretan (Yoğunluk 18 kg/m<sup>3</sup>). Пенополиуретан (Плотность 18 кг/м<sup>3</sup>) с покрытием из обшивки из полиэстера (Плотность 100 гр/м<sup>2</sup>).

56% poliéster y 44% poliuretano. Tratamiento para repeler el agua, antimanchas, antimoho y antibacteriano. Solidez a la luz 7/8. Lavable a 95° con detergente neutro.

56% de poliéster e 44% poliuretano. Tratamento hidrorrepelente, antimancha, antimoho e antibacteriano. Resistência à luz 7/8. Lavável a 95° com detergente neutro.

% 56 polyester ve % 44 poliüretan. Su Geçirmez Uygulama,kir tutmaz ve küf önleyici uygulama, antibakteriyel uygulama. Işık haslığı 7/8. Naturel deterjanla 95°de yıkanabilir.

56% полиэстер и 44% полиуретан. типы обработки: водоталкивающая,пятноталкивающая,плесеньоталкивающая, и антибактериальная устойчивость к. Светостойкость 7/8. Можно стирать при 95 ° с нейтральным моющим средством.

### CUSCINO BIT

Poliuretano espanso (densità 17,10 kg/m<sup>3</sup>) rivestito da fibra di poliestere (densità 200 gr/m<sup>2</sup>). Polyurethane foam (density 17,10 kg/m<sup>3</sup>) with a polyester fiber coating (density 200 gr/m<sup>2</sup>). Mousse polyuréthane (densité 17,10 kg/m<sup>3</sup>) revêtu de fibre de polyester (densité 200 gr/m<sup>2</sup>). Polyurethanschäum (Dichte 17,10 kg/m<sup>3</sup>) mit Polyesterfasern beschichtet (Dichte 200 gr/m<sup>2</sup>). Espuma de poliuretano (densidad 17,10 kg/m<sup>3</sup>) cubierta con fibras de poliéster (densidad 200 gr/m<sup>2</sup>). Espuma de poliuretano (densidade 17,10 kg/m<sup>3</sup>) com cobertura fibras de poliéster (densidade 200 gr/m<sup>2</sup>). Polyester elyaf (Yoğunluk 200 gr/m<sup>2</sup>) kaplı köpük poliüretan (Yoğunluk 17,10 kg/m<sup>3</sup>). Пенополиуретан (Плотность 17,10 кг/м<sup>3</sup>) с покрытием из обшивки из полиэстера (Плотность 200 гр/м<sup>2</sup>).

### CUSCINO PASSEPARTOUT - CUSCINO RETTANGOLARE

Fibra di poliestere. Polyester fiber. Fibre de polyester. Polyesterfasern. Fibras de poliéster. Fibras de poliéster. Polyester elyaf. Обшивка из полиэстера.

### CUSCINO SEDUTA KOMODO - CUSCINO ARREDO ARIA

Poliuretano espanso (densità 25 kg/m<sup>3</sup>) rivestito da fibra di poliestere (densità 450 gr/m<sup>2</sup>). Polyurethane foam (density 25 kg/m<sup>3</sup>) with a polyester fiber coating (density 450 gr/m<sup>2</sup>). Mousse polyuréthane (densité 25 kg/m<sup>3</sup>) revêtu de fibre de polyester (densité 450 gr/m<sup>2</sup>). Polyurethanschäum (Dichte 25 kg/m<sup>3</sup>) mit Polyesterfasern beschichtet (Dichte 450 gr/m<sup>2</sup>). Espuma de poliuretano (densidad 25 kg/m<sup>3</sup>) cubierta con fibras de poliéster (densidad 450 gr/m<sup>2</sup>). Espuma de poliuretano (densidade 25 kg/m<sup>3</sup>) com cobertura fibras de poliéster (densidade 450 gr/m<sup>2</sup>). Polyester elyaf (Yoğunluk 450 gr/m<sup>2</sup>) kaplı köpük poliüretan (Yoğunluk 25 kg/m<sup>3</sup>). Пенополиуретан (Плотность 25 кг/м<sup>3</sup>) с покрытием из обшивки из полиэстера (Плотность 450 гр/м<sup>2</sup>).

### CUSCINO SCHIENALE KOMODO - CUSCINO SCHIENALE ANGOLO KOMODO

Poliuretano espanso (densità 21 kg/m<sup>3</sup>) rivestito da fibra di poliestere (densità 450 gr/m<sup>2</sup>). Polyurethane foam (density 21 kg/m<sup>3</sup>) with a polyester fiber coating (density 450 gr/m<sup>2</sup>). Mousse polyuréthane (densité 21 kg/m<sup>3</sup>) revêtu de fibre de polyester (densité 450 gr/m<sup>2</sup>). Polyurethanschäum (Dichte 21 kg/m<sup>3</sup>) mit Polyesterfasern beschichtet (Dichte 450 gr/m<sup>2</sup>). Espuma de poliuretano (densidad 21 kg/m<sup>3</sup>) cubierta con fibras de poliéster (densidad 450 gr/m<sup>2</sup>). Espuma de poliuretano (densidade 21 kg/m<sup>3</sup>) com cobertura fibras de poliéster (densidade 450 gr/m<sup>2</sup>). Polyester elyaf (Yoğunluk 450 gr/m<sup>2</sup>) kaplı köpük poliüretan (Yoğunluk 21 kg/m<sup>3</sup>). Пенополиуретан (Плотность 21 кг/м<sup>3</sup>) с покрытием из обшивки из полиэстера (Плотность 450 гр/м<sup>2</sup>).

### CUSCINO EDEN

Poliuretano espanso. Densità 18 kg/m<sup>3</sup>. Polyurethane foam. Density 18 kg/m<sup>3</sup>. Mousse polyuréthane. Densité 18 kg/m<sup>3</sup>. Polyurethanschäum. Dichte 18 kg/m<sup>3</sup>. Espuma de poliuretano. Densidad 18 kg/m<sup>3</sup>. Espuma de poliuretano. Densidade 18 kg/m<sup>3</sup>. Poliüretan köpük. Yoğunluk 18 kg/m<sup>3</sup>. Пенополиуретан. Плотность 18 кг/м<sup>3</sup>.

## tessuto sintetico

Tessuto in filo di poliestere rivestito in pvc. Fabric is made of a polyester fiber, with a pvc coating. Tissu en fil de polyester revêtu de pvc. Gewebe aus PVC-ummantelten Polyesterfasern.

Tejido en hilo de poliester recubierto de pvc. Tecido de fibra polyester com cobertura pvc. PVC kaplı polyester elyaf tekstil. Ткань из полиэфирных нитей с покрытием из ПВХ.



bianco .107

tela 1x1



tortora .104

tela 1x1

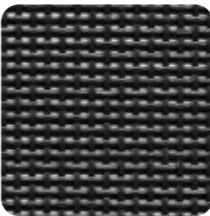

antracite .057

tela 1x1

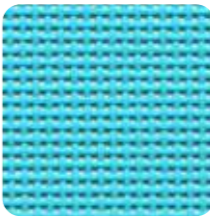

celeste .075

tela 1x1



agave .101

tela 2x1



deserto .103

tela 2x1



bianco .108

tela 2x2



beige .115

tela 2x2



tortora .124

tela 2x2



blu .112

tela 2x2

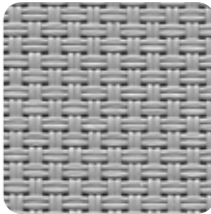

grigio .086

tela 2x2



trama caffè .117

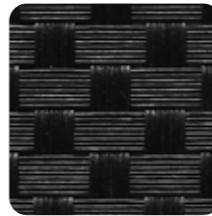

trama antracite .116

## alluminio

### verniciato

La verniciatura è a polvere di poliesteri. The painting is with polyester powder. La peinture est à poudre de polyester. Die Epoxierung erfolgt mit Polyesterpulver. El pintado

se realiza con polvo de poliéster. O pó de poliéster é usado para envernizar. Boyası polyester tozla yapılır. Окраска производится при помощи порошкового полиэстера.

### verniciato - trattamento speciale

Trattamento speciale per ambienti ad alto tasso salino. Special treatment for high salinity environments. Traitement spécial pour les environnements à haute salinité. Sonderbehandlung für Ambiente mit hohem Salzgehalt. Tratamiento especial para ambientes con alta

salinidad. Tratamento especial para ambientes com alto teor de sal. Yüksek tuza maruz kalan alanlar için özel bakım. Специальная обработка для среды с высоким содержанием соли.



verniciato bianco .53



verniciato argento .54



verniciato antracite .52



verniciato tortora .59



verniciato caffè .57



verniciato agave .66

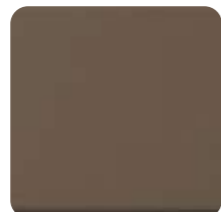

verniciato tabacco .67

## laminato HPL (10 mm)

Laminato decorativo ad alta pressione, compatto, omogeneo, non poroso, ad alta densità. Spessore 10 mm. Decorative high pressure laminate, solid, homogeneous, non-porous and with a high density. Thickness 10 mm. Stratifié décoratif à haute pression, condensé, homogène, pas poreux, haute densité. Epaisseur 10 mm. HPL-Laminat, beständig, homogen, hoch verdichtet. Dicke 10 mm.

Laminado decorado a alta presión, compacto, homogéneo, no poroso y de alta densidad. Espesor 10 mm. Decorativo e laminado a alta pressão, sólido, homogéneo, não poroso e de grande densidade. Espessura 10 mm. Dekoratif yüksek basınçlı laminat, masif, gözeneksiz ve yüksek yoğunluklu. Kalınlık 10 mm. Декоративный ламинат высокого давления, компактный, однородный, непористый, с высокой плотностью. Толщина 10 мм.

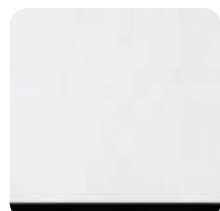

BIANCO .301



GRIGIO .300

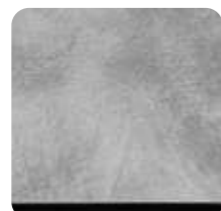

CEMENTO .305



ANTRACITE .303



TORTORA .310



LEGNO .311

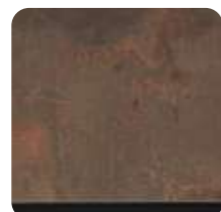

CORTEN .312



CAFFÈ .302



TABACCO.317



AGAVE .316

## laminato HPL Solid Core

Laminato decorativo ad alta pressione, compatto, omogeneo, non poroso, ad alta densità. Spessore 10 mm. Decorative high pressure laminate, solid, homogeneous, non-porous and with a high density. Thickness 10 mm. Stratifié décoratif à haute pression, condensé, homogène, pas poreux, haute densité. Epaisseur 10 mm. HPL-Laminat, beständig, homogen, hoch verdichtet. Dicke 10 mm.

Laminado decorado a alta presión, compacto, homogéneo, no poroso y de alta densidad. Espesor 10 mm. Decorativo e laminado a alta pressão, sólido, homogéneo, não poroso e de grande densidade. Espessura 10 mm. Dekoratif yüksek basınçlı laminat, masif, gözeneksiz ve yüksek yoğunluklu. Kalınlık 10 mm. Декоративный ламинат высокого давления, компактный, однородный, непористый, с высокой плотностью. Толщина 10 мм.



TOTAL WHITE .314

## Fenix NTM®/Solid

Spessore 10 mm. Thickness 10 mm. Epaisseur 10 mm. Dicke 10 mm. Espesor 10 mm. Espessura 10 mm. Kalınlık 10 mm. Толщина 10 мм.



NERO FENIX NTM® .313



TORTORA FENIX .318

## vetro

Vetro float temperato serigrafato e vetrificato a 700°C. Spessore 10 mm. Tempered float glass, screen-printed and vitrified at 700°C. Thickness 10 mm. Verre float trempé sérigraphié et vitrifié à 700°C. Epaisseur 10 mm. Sicherheitsglas mit innenliegendem Dekorsiebdruck, verglast bei 700°. Dicke 10 mm. Vidrio float, templado, serigrafado y vetrificado a 700°C. Espesor 10 mm. Vidro float temperado, impresso e vitrificado a 700°C. Espessura 10 mm. Temperli, üstü baskılı ve 700° C vitriyiye edilmiş. Kalınlık 10 mm. Сериграфированное закаленное стекло float, производимое при 700°C. Толщина 10 мм.



BIANCO .00



ANTRACITE .02

## vetro

Vetro extrachiaro temperato. Spessore 6 mm. Extra-clear tempered glass. Thickness 6 mm. Verre trempé extra clair. Epaisseur 6 mm. Extra klares gehärtetes Glas. Dicke 6 mm. Vidrio templado extra claro. Espesor 6 mm. Vidro temperado extra claro. Espessura 6 mm. Ekstra net temperli cam. Kalınlık 6 mm. Особо прозрачное закаленное стекло. Толщина 6 мм.



vetro .501

## durelTOP







DurelTOP è un sistema innovativo di produzione di piani per tavoli studiati per raggiungere i più elevati livelli di praticità, resistenza, robustezza ed eleganza. I piani DurelTOP sono ad alto spessore, formati da un doppio strato tamburato perfettamente chiuso. Prodotti in polipropilene di prima qualità, sono inalterabili all'acqua, resistenti al sole e facili da pulire. DurelTOP è il risultato di una lunga ricerca tecnologica e dell'esperienza decennale nella lavorazione delle materie plastiche della NARDI, da sempre all'avanguardia nell'ambiente contract e giardino.

The DurelTOP is an innovative new system in the production of tabletops developed to reach the highest levels of practicality, resistance, and elegance. The DurelTOP tabletops have a greater thickness, formed by a double layer enclosure perfectly closed. Produced in first quality polypropylene, they are resistant to water, resistant to sunlight, and are easy to clean. DurelTOP is a result of a decade's long research and development in plastics by NARDI, always a leader in the contract and garden sectors.

DurelTOP est un système innovateur de production de plateaux de tables, il est étudié pour retrouver le meilleur niveau de pratique de résistance et d'élégance. Les plateaux DurelTOP sont très épais, formés de doubles couches parfaitement finies. Ce sont des produits en polypropylène de première qualité, ils sont inaltérables à l'eau, résistant au soleil et faciles à nettoyer. DurelTOP est le résultat d'une longue recherche technologique et une expérience décennale dans le travail des matières plastique de la Sté NARDI, toujours a l'avantgarde dans le secteur du contract et jardin.

DurelTOP ist ein neu entwickeltes System für die Produktion von Tischplatten, um ein Höchstmaß an Funktionalität, Widerstandsfähigkeit und Eleganz zu erreichen. Durch das innen verstärktes "Zwei-Schichten-Hohlraum-System" erreicht die DurelTOP Tischplatte einen stärkeren Querschnitt und damit ein Höchstmaß an Festigkeit. Hergestellt aus hochwertigem Qualitätspolypropylen ist sie resistent gegen Wasser und Sonnenlicht und dabei leicht zu reinigen. DurelTOP ist das Ergebnis von 10 Jahren Forschung und Entwicklung auf dem Kunststoffsektor durch NARDI, immer der führende im Bereich Contract- und Gartenmöbel.



	impilabile stackable empilable stapelbar apilable empilhável istiflenebilir стекируемые
	impilabile orizzontalmente stackable horizontally piètement encastrable lneinander stapelbar apilable horizontalmente empilhável horizontalmente yatay olarak istiflenebilir горизонтальная расстановка
	pieghevole folding pliant klappbar plegable dobrável katlanabilir складывающийся
	reclinabile reclining dossier réglable verstellbare Rückenlehne reclinable reclinável sırt pozisyonlu откидной

Tutte le sedute sono dotate di piedini antiscivolo. All chairs are equipped with non-slip feet. Tous les sièges sont équipés avec patins anti-dérapants. Alle Stühle sind mit rutschfesten Fußkappen ausgestattet. Todos los asientos están equipados con tapones antideslizantes. Todos os assentos estão equipados com pés antiderrapantes. Bütün sandalyeler kaymaz ayaklıdırlar. Ножки всех стульев оснащены противоскользящей резиновой подложкой.



Sui colori scuri, ombre, striature ed altri difetti minori sono più evidenti rispetto ai colori chiari e sono da ritenersi standard. On dark colors, shadows, streaks and other minor faults are more evident than on lighter colors and are therfore standard. Sur les couleurs sombres, les ombres, les stries et les autres petits défauts sont plus marqués que sur les couleurs claires et sont tout à fait standards. Auf dunklen Farben sind Schatten, Streifen und andere kleinere Mängel sichtbarer als auf hellen Farben und sind daher als Standard zu betrachten. Las sombras, rayas y demás defectos menores son más evidentes sobre los colores oscuros respecto a los colores claros y tienen que considerarse como estándares. Em cores escuras, sombras, listras e outros defeitos menores são mais evidentes do que em cores claras e devem ser considerados standard. Koyu renkler üzerinde, gölgeler, çizgiler ve diğer küçük defolar açık renkler üzerinde olduklarından daha belirginleşmekte ve bu nedenle normal olarak değerlendirilmelidirler. По сравнению со светлыми цветами на темных цветах тени полоска и другие небольшие дефекты более заметны и должны считаться нормой.

Il peso (kg), le misure (cm) e i colori riportati sono indicativi. La NARDI si riserva il diritto di apportare modifiche o varianti senza preavviso. Tutti i modelli sono depositati. Weights (kg), dimensions (cm) and colors are indicative only. NARDI reserves the right to make changes or variations without notice. All models are patented. Le poids (kg), les dimensions (cm) et les coloris indiqués sont fournis purement à titre indicatif. La Firme NARDI se réserve le droit d'apporter toute modification ou variation sans aucun préavis. Tous les modèles sont déposés. Alle Farb-, Maß- (cm) und Gewichtsangaben (kg) sind nicht als fest binded anzusehen Firma NARDI behalt sich das Recht von Anderungen Alle Modelle sind gesetzlich geschützt. El peso (kg), las medidas (cm) y los colores detallados, son indicativos. La firma NARDI se reserva el derecho de modificaciones o variaciones sin previo aviso. Todos los modelos llevan nuestra marca. O peso (kg), as medidas (cm) e as cores indicadas, são indicativos. A NARDI reservase o direito de aportar modificações ou variações sem préaviso. Todos os modelos estão depositados. Ağırlık (Kg), boyutlar (cm) ve renkler gösterme amaçlıdır. NARDI'nin önceden bildirmeden değişiklik yapma hakkı vardır. Bütün modeller patentlidir. Приведенный вес (кг), размеры (см) и цвета являются ориентировочными. Компания NARDI оставляет за собой права вносить изменения и вариации без предварительного предупреждения. Все модели зарегистрированы.



**NARDI s.p.a.**  
Chiampo (VI) Italy  
tel. +39 0444 422100  
info@nardioutdoor.com  
www.nardioutdoor.com



10101130